TABLE OF CONTENTS

1.0 WRG-0126	3
1.1 MP12_OMM_FANUC_CNT	3
2.0 WRG-0127	4
2.1 TS27_PROBE_FANUC	4
3.0 WRG-0133	5
3.1 FANUC OPERATOR DOOR INTERLOCK VMC_ SHT1	5
3.2 FANUC TOOL DOOR INTERLOCK VMC_ SHT2	6
4.0 WRG-0136	7
4.1 FANUC NC4 PROBE	7
5.0 WRG-0140	8
5.1 OR 01_DRAWING STANDARDS AND INDEX	8
5.2 C02_OPERATOR STATIONS COMMUNICATION 1 LINE OVERVIEW	9
5.3 E01_230VAC POWER DISTRIBUTION	10
5.4 E02_FADAL SUPPLIED TRANSFORMER DETAIL	11
5.5 E170_115VAC POWER DISTRIBUTION_SHT1	12
5.6 E171_115VAC POWER DISTRIBUTION_SHT2	13
5.7 E172_115VAC POWER DISTRIBUTION_SHT3	14
5.8 E173_115VAC POWER DISTRIBUTION_SHT4	15
5.9 E180_24VDC POWER DISTRIBUTION	16
5.10 E300_DRIVES POWER SUPPLY WIRING DETAIL	17
5.11 E350_DRIVES CNC CONTROL WIRING DETAIL	18
5.12 E400_SPINDLE AMP DRIVE WIRING DETAIL	19
5.13 E450_SERVO AMP DRIVE WIRING DETAIL FOR X, Y, Z AXIS	20

5.14 E600_OPTIONAL SERVO AMP DRIVE WIRING DETAIL FOR A & B AXIS MOTORS	21
5.15 E801_INPUT CARD FOR C001 BOARD_SHT1	22
5.16 E802_INPUT CARD FOR C001 BOARD_SHT2	23
5.17 E803_INPUT CARD FOR C001 BOARD_SHT3	24
5.18 E804_C001 BOARD JUMPER SETUP DETAIL	25
5.19 E805_INPUT CARD FOR C003 BOARD_SHT1	26
5.20 E806_INPUT CARD FOR C003 BOARD_SHT2	27
5.21 E807_INPUT CARD FOR C003 BOARD_SHT3	28
5.22 E808_C003 BOARD JUMPER SETUP DETAIL	29
5.23 E809_C004 BOARD JUMPER SETUP DETAIL_SHT1	30
5.24 E810_C004 BOARD JUMPER SETUP DETAIL_SHT2	31
5.25 E850_OUTPUT CARD FOR C001 BOARD_SHT1	32
5.26 E851_OUTPUT CARD FOR C001 BOARD_SHT2	33
5.27 E852_OUTPUT CARD FOR C003 BOARD_SHT1	34
5.28 E853_OUTPUT CARD FOR C003 BOARD_SHT2	35
5.29 E854_OUTPUT CARD FOR C004-1 BOARD_SHT1	36
5.30 E855_OUTPUT CARD FOR C004-1 BOARD	37
5.31 E856_OUTPUT CARD FOR C004-2 BOARD_SHT1	38
5.32 E857_OUTPUT CARD FOR C004-2 BOARD_SHT2	39

FANUC WIRING DIAGRAM

1.0 WRG-0126

2.0 WRG-0127

3.0 WRG-0133

4.0 WRG-0136

5.0 WRG-0140



1.1 MP12_OMM_FANUC_CNT

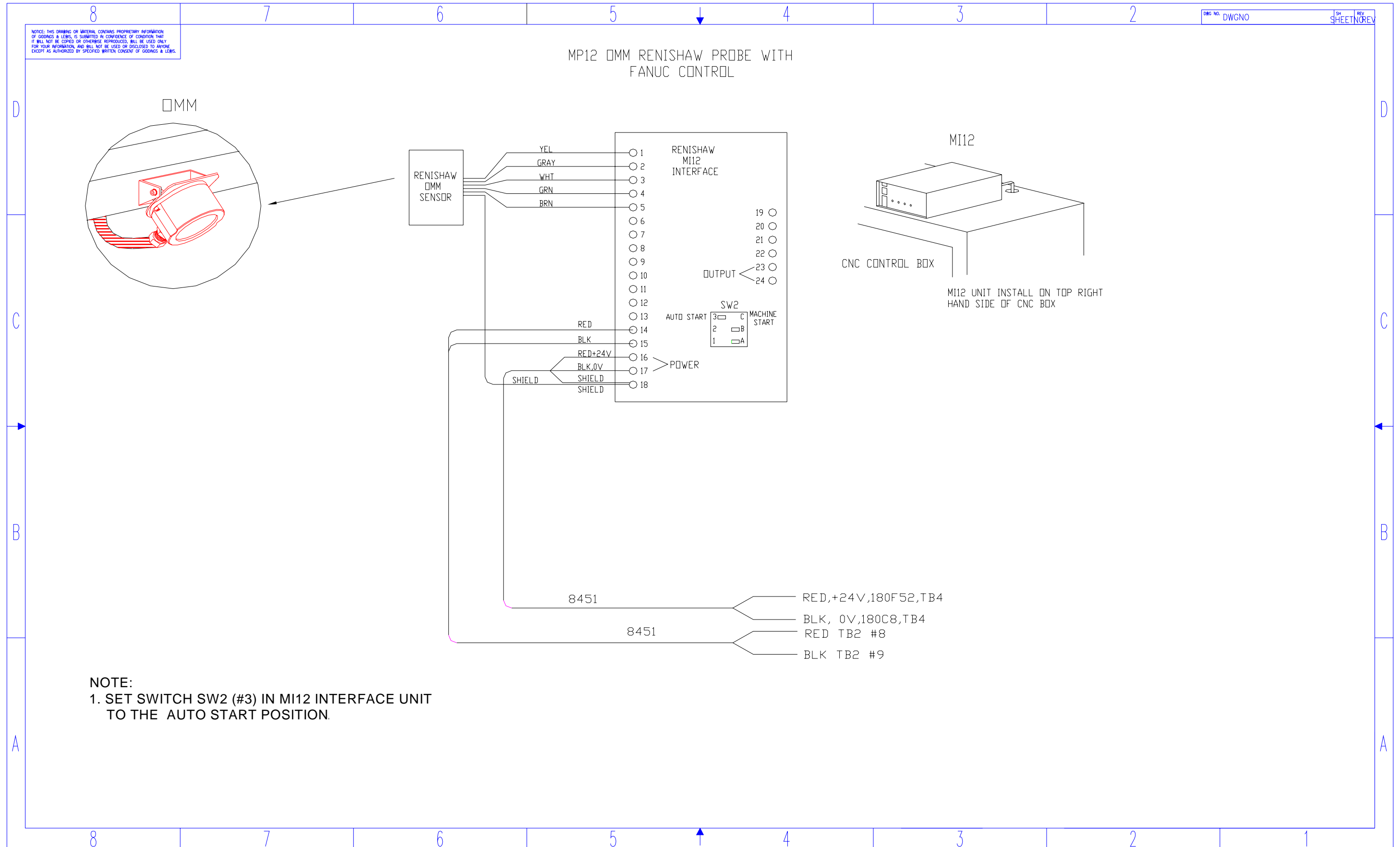

3.1 FANUC OPERATOR DOOR INTERLOCK VMC_SHT1

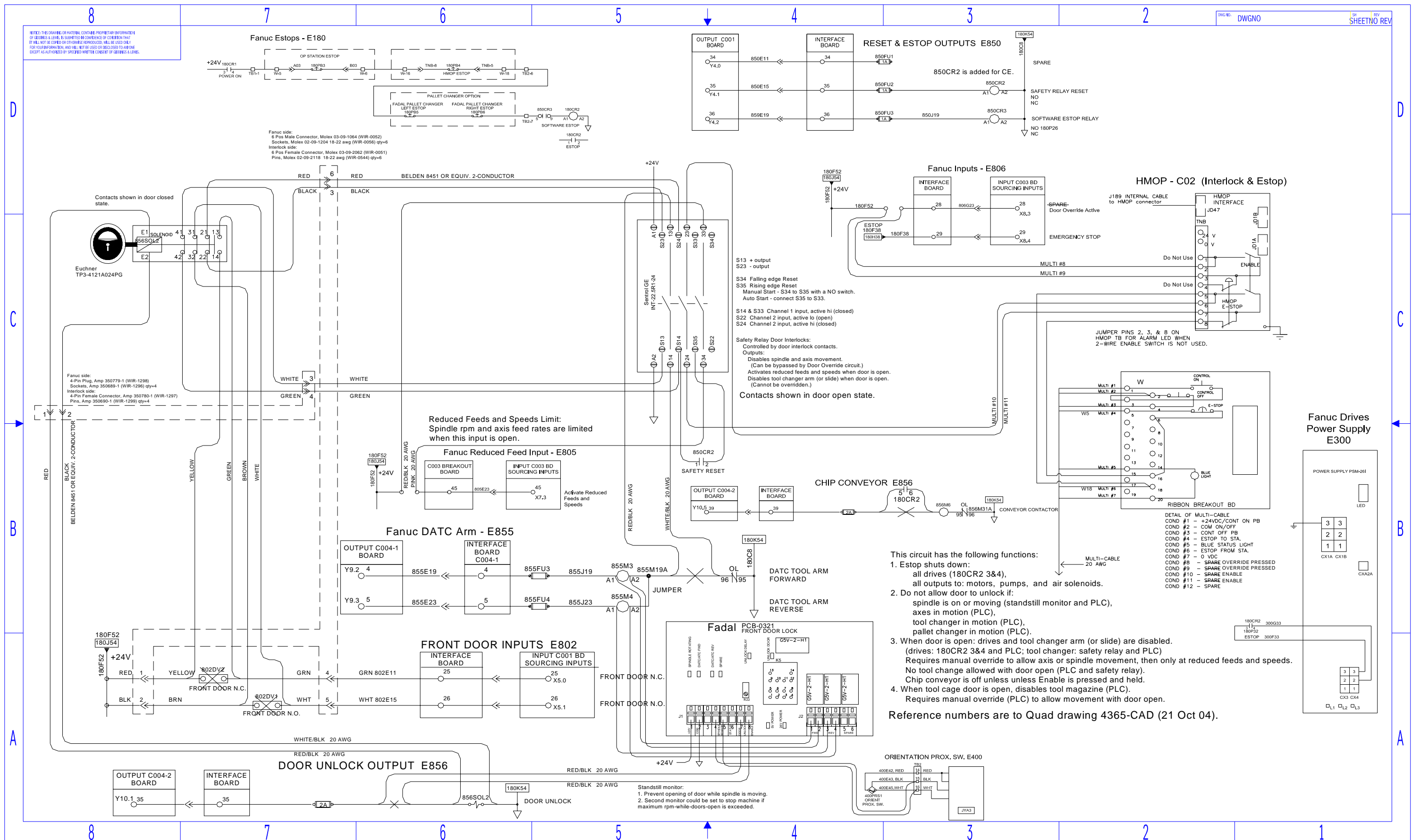

3.2 FANUC TOOL DOOR INTERLOCK VMC_SHT2

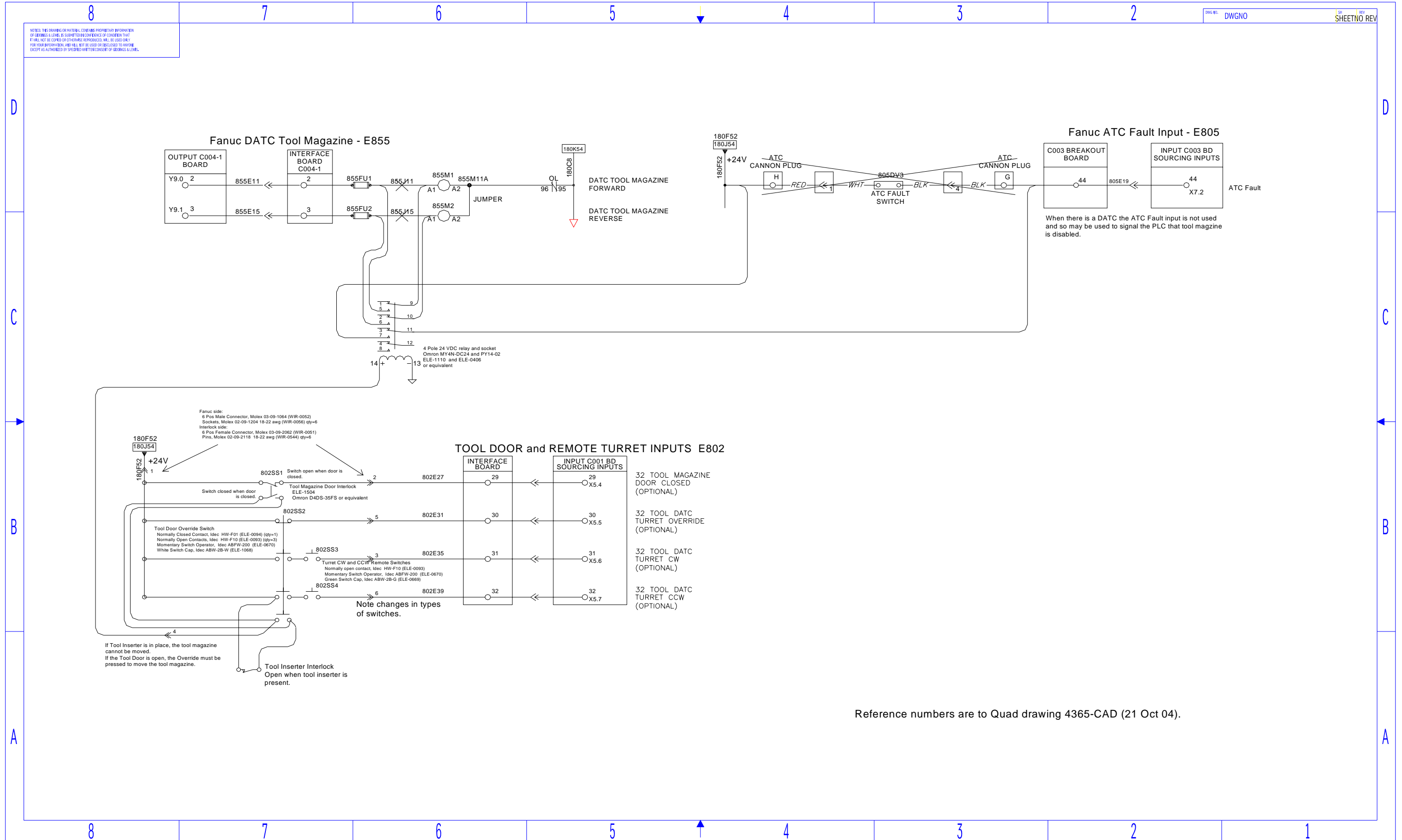

4.1 FANUC NC4 PROBE

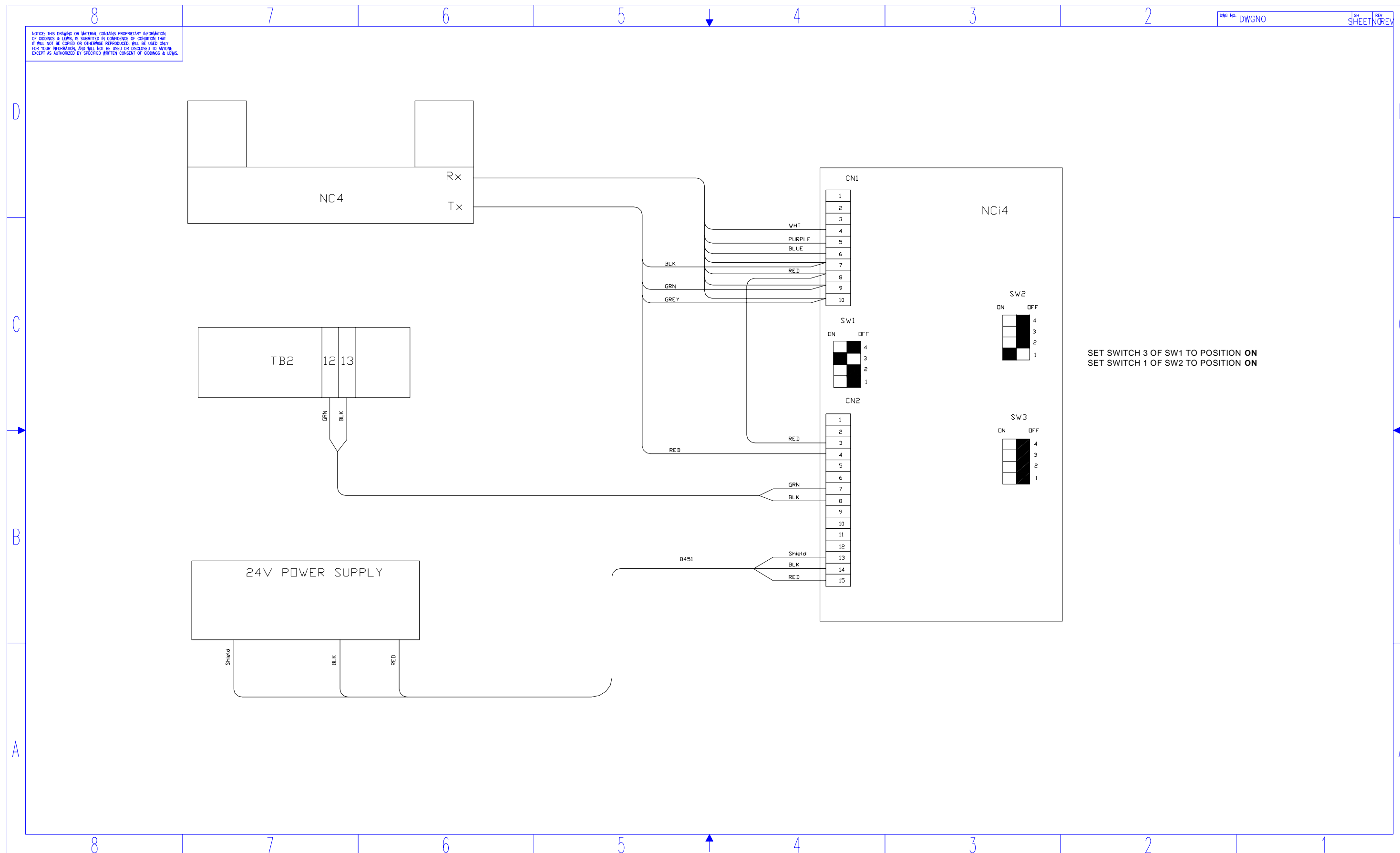

5.1 OR 01_DRAWING STANDARDS AND INDEX

01	A	B	C	D	E	F	G	H	J	K	M	N	P	Q	DWG NO. DWGNO	SH R01	REV A	01
02	<p>NOTICE: THIS DRAWING OR MATERIAL CONTAINS PROPRIETARY INFORMATION OF GEORGING & LEWIS. IS SUBMITTED IN CONFIDENCE OF CONDITION THAT IT WILL NOT BE COPIED OR OTHERWISE REPRODUCED, WILL BE USED ONLY FOR YOUR INFORMATION, AND WILL NOT BE USED OR DISCLOSED TO ANYONE EXCEPT AS AUTHORIZED BY SPECIFIED WRITTEN CONSENT OF GEORGING & LEWIS.</p>																	02
03	<h2>DRAWING STANDARDS</h2>																	03
04	<p>NOTES</p> <p><u>CxS</u> \ (x) CONDUCTOR SHIELDED - 18 Ga.</p> <p><u>CxPS</u> \ (x) PAIR INDIVIDUALLY SHIELDED - 18 Ga.</p> <p><u>CBH</u> \ ALLEN BRADLEY BLUE HOSE - 18 Ga.</p> <p><u>CFO</u> \ FIBER OPTIC CABLE</p> <p><u>N"#"</u> \ DENOTES REFER TO NOTE "#" LISTED ON SAME SHEET i.e.: N2 "REFER TO NOTE 2"</p>																	04
05	<p>FIELD INSTALLATION & WIRING</p> <p>TO REDUCE THE POSSIBILITY OF ELECTRICAL NOISE INTERFERING WITH THE PROPER OPERATION OF THE CONTROL SYSTEM, FIELD WIRING MUST CONFORM TO THE FOLLOWING POWER SEPARATION RULES:</p> <p>FIELD WIRING AND INSTALLATION INDICATED ON THE DRAWINGS BY THE FOLLOWING:</p> <p>1 LOW LEVEL SIGNAL WIRE * ANALOG SIGNALS LESS THAN 50V * DIGITAL SIGNALS LESS THAN 15V * FIBER-OPTIC SIGNAL CABLES</p> <p>2 MEDIUM LEVEL SIGNAL WIRE * ANALOG SIGNALS GREATER THAN 50V * SWITCHING SIGNALS GREATER THAN 15V</p> <p>3 NON-SIGNAL WIRE (300V/20A MAX) * SWITCHING SIGNALS GREATER THAN 50V * ANALOG SIGNALS GREATER THAN 50V * REGULATING SIGNALS OF 50V WITH CURRENTS LESS THAN 20A * AC FEED 20A OR LESS</p> <p>4 ALL OTHER POWER WIRE * AC/DC BUSES UP TO 1000V WITH CURRENTS UP TO 800A * CLASS 4S FOR POWER GREATER THAN 1000V AND/OR 800A * LEVELS MUST BE RUN IN SEPARATE CONDUIT/TRAYS, NO INTERMIXING OF LEVELS IS PERMITTED</p> <p>G GROUNDING CONDUCTOR</p>																	05
06	<p>DEVICE DESIGNATIONS</p> <p style="text-align: center;"> $\begin{array}{c} X/ \\ \\ XXX \\ \quad \quad \\ B \quad C \quad D \end{array}$ </p> <p>A - (OPTIONAL) LOCATION CABINET NUMBER/LETTER B - SHEET NUMBER C - DEVICE FAMILY DESCRIPTION (ABBREVIATION) D - SEQUENTIAL DEVICE NUMBER</p>																	06
07	<p>WIRE NUMBERING</p> <p style="text-align: center;"> $\begin{array}{c} XXX \quad X \quad XX \\ \quad \quad \\ A \quad B \quad C \end{array}$ </p> <p>A - SHEET NUMBER B - HORIZONTAL GRID LOCATION (LETTER) C - SEQUENTIAL OR VERTICAL GRID LOCATION (NUMBER)</p>																	07
08	<p>REFERENCES (IN BRACKETS)</p> <p style="text-align: center;"> $\left[\begin{array}{c} XXX \quad X \quad XX \\ \quad \quad \\ A \quad B \quad C \end{array} \right]$ </p> <p>A - SHEET NUMBER B - HORIZONTAL GRID LOCATION (LETTER) C - (OPTIONAL) VERTICAL GRID LOCATION (NUMBER)</p>																	08
09	<p>SHEET NUMBER DESIGNATIONS</p> <p style="text-align: center;"> $\begin{array}{c} X \quad XXX \\ \quad \\ A \quad B \end{array}$ </p> <p>A = R - REFERENCE SHEET S - SYSTEM OVERVIEW C - COMMUNICATIONS OVERVIEW/CONTROL SINGLE LINE D - DISTRIBUTION SINGLE LINE E - ELECTRICAL SCHEMATICS M - MECHANICAL DRAWINGS B = SEQUENTIAL DRAWING NUMBER</p>																	09
10	<h2>DRAWING INDEX</h2>																	10
11	<p>R01 DRAWING STANDARDS AND INDEX</p> <p>C02 OPERATOR STATIONS COMMUNICATION 1 LINE OVERVIEW</p> <p>E01 230VAC POWER DISTRIBUTION E02 FADAL SUPPLIED TRANSFORMER DETAIL E170 115VAC POWER DISTRIBUTION E171 115VAC POWER DISTRIBUTION E172 115VAC POWER DISTRIBUTION E173 115VAC POWER DISTRIBUTION E180 24VDC POWER DISTRIBUTION E300 DRIVES POWER SUPPLY WIRING DETAIL E350 DRIVES CNC CONTROL WIRING DETAIL E400 SPINDLE AMP DRIVE WIRING DETAIL E450 SERVO AMP DRIVE WIRING DETAIL FOR X, Y, Z, AXIS MOTORS E600 OPTIONAL SERVO AMP DRIVE WIRING DETAIL FOR A & B AXIS MOTORS E801 INPUT CARD FOR C001 BOARD E802 INPUT CARD FOR C001 BOARD E803 INPUT CARD FOR C001 BOARD E804 C001 BOARD JUMPER SETUP DETAIL E805 INPUT CARD FOR C003 BOARD E806 INPUT CARD FOR C003 BOARD E807 INPUT CARD FOR C003 BOARD E808 C003 BOARD JUMPER SETUP DETAIL E809 C004 BOARD JUMPER SETUP DETAIL E810 C004 BOARD JUMPER SETUP DETAIL E850 OUTPUT CARD FOR C001 BOARD E851 OUTPUT CARD FOR C001 BOARD E852 OUTPUT CARD FOR C003 BOARD E853 OUTPUT CARD FOR C003 BOARD E854 OUTPUT CARD FOR C004-1 BOARD E855 OUTPUT CARD FOR C004-1 BOARD E856 OUTPUT CARD FOR C004-2 BOARD E857 OUTPUT CARD FOR C004-2 BOARD</p> <p>M200 MAG PANEL LAYOUT M201 REAR PANEL LAYOUT M202 RIGHT SIDE PANEL LAYOUT M205 ENCLOSURE PANEL LOCATION DETAILS M210 MAG PANEL FABRICATION DETAIL M211 REAR CONTROL PANEL FABRICATION DETAIL M212 RIGHT SIDE PANEL FABRICATION DETAIL</p>																	11
12																		12
13																		13
14																		14
15																		15
16																		16
17																		17
18																		18
19																		19
20																		20
21																		21
22																		22
23																		23
24																		24
25																		25
26																		26
27																		27
28																		28
29																		29
30																		30
31																		31
32																		32
33																		33
34																		34
35																		35
36																		36
37																		37
38																		38
39																		39
40																		40
41																		41
42																		42
43																		43
44																		44
45																		45
46																		46
47																		47
48																		48
49																		49
50																		50
51																		51
52																		52
53																		53
54																		54
55																		55
56																		56
57																		57
58																		58
59																		59
60																		60
61																		61
62																		62
63																		63
64																		64
65																		65
66																		66
67																		67
68																		68
69																		69
70																		70
71																		71
72																		72
73																		73
74																		74
75																		75
76																		76
77	A	B	C	D	E	F	G	H	J	K	M	N	P	Q	R	S		77

5.2 C02_OPERATOR STATIONS COMMUNICATION 1 LINE OVERVIEW

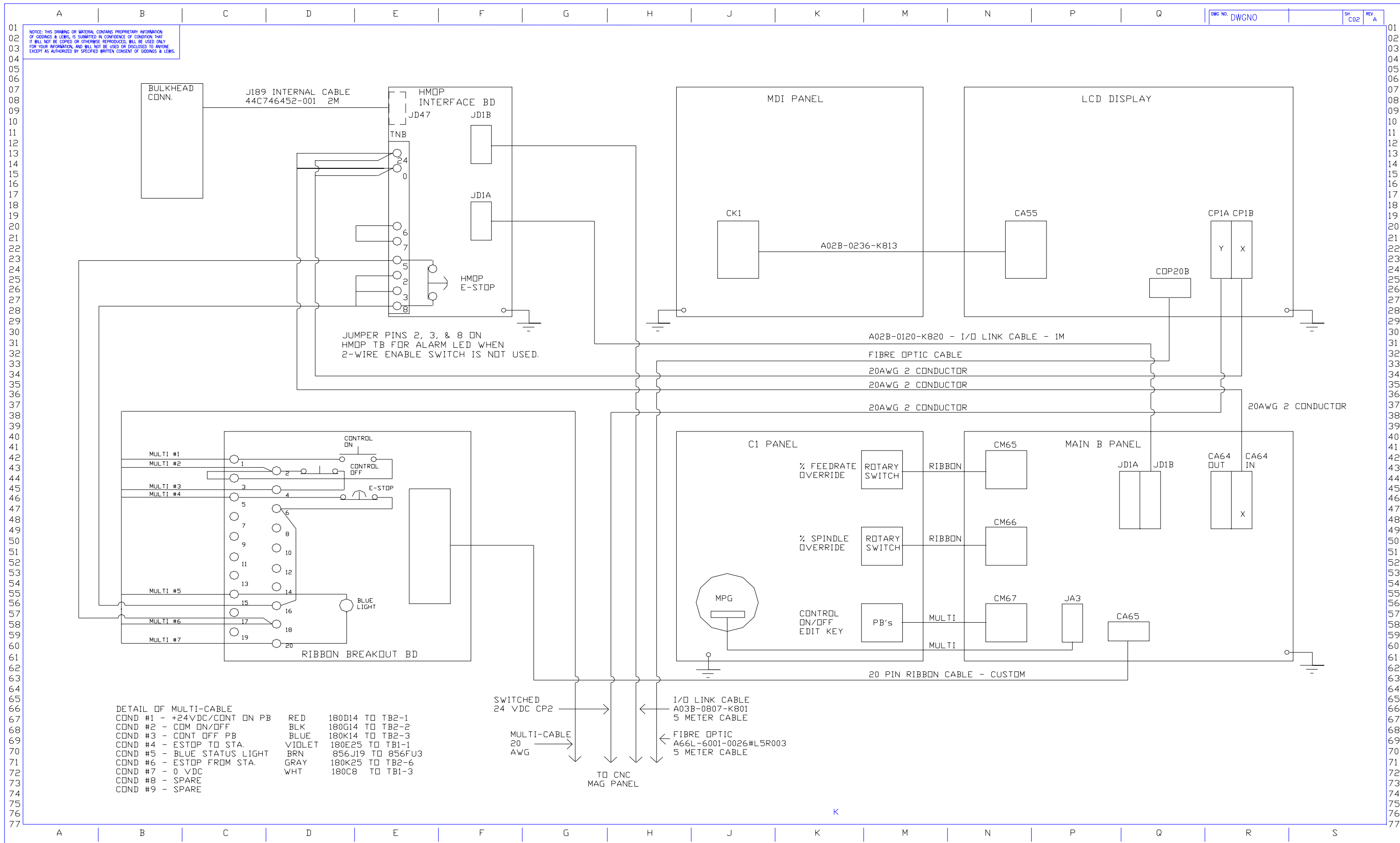

5.3 E01_230VAC POWER DISTRIBUTION

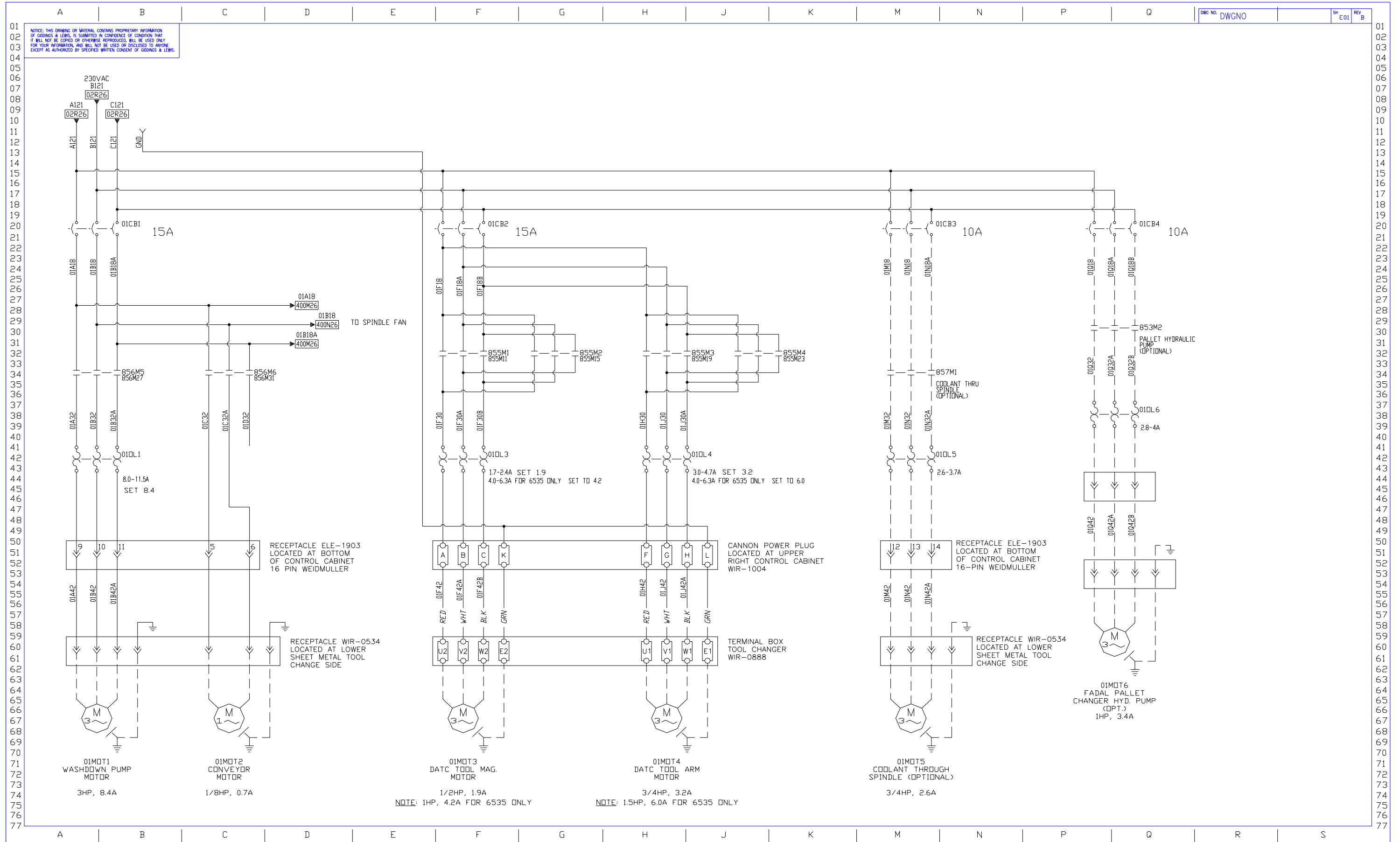

5.4 E02_FADAL SUPPLIED TRANSFORMER DETAIL

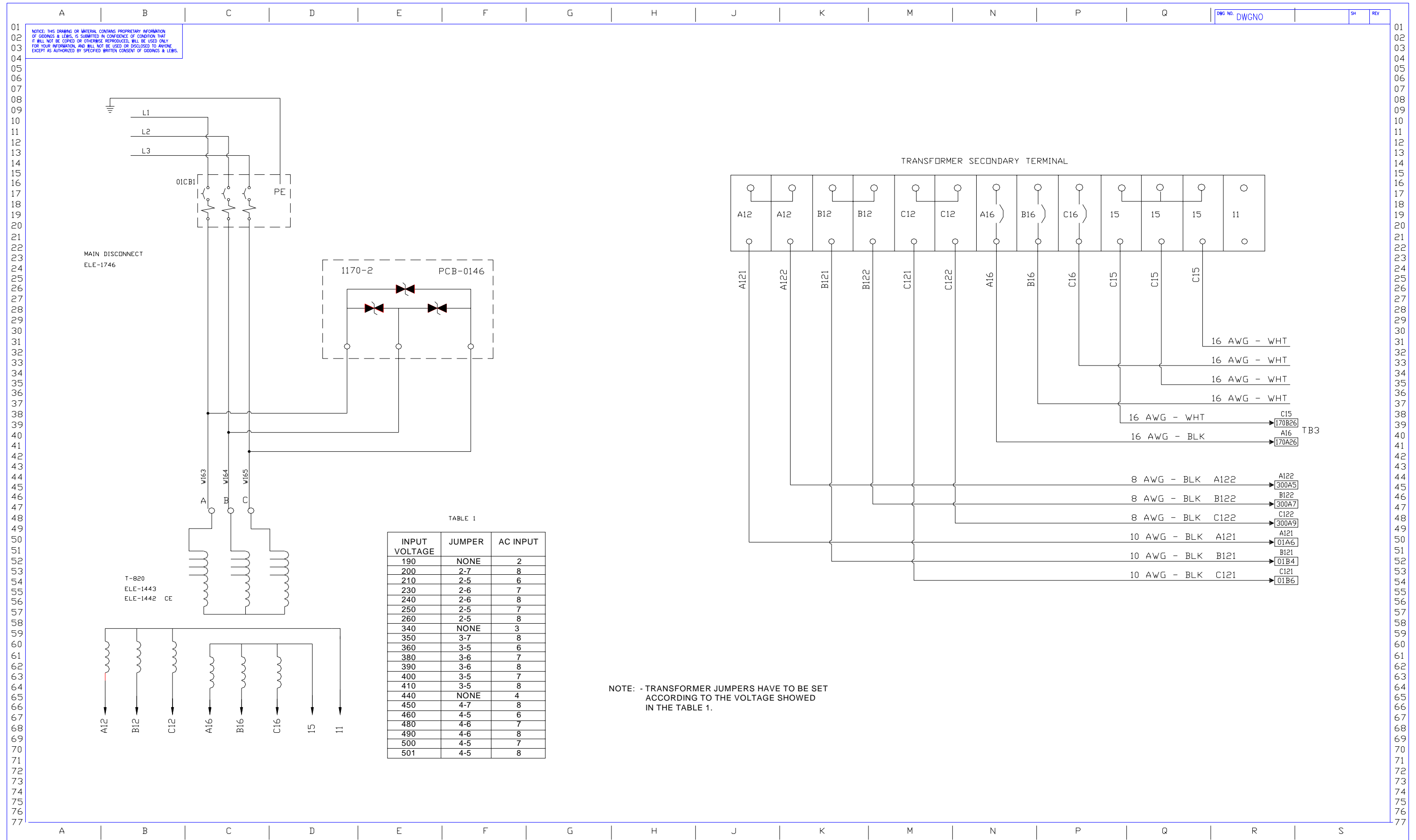

5.5 E170_115VAC POWER DISTRIBUTION_SHT1

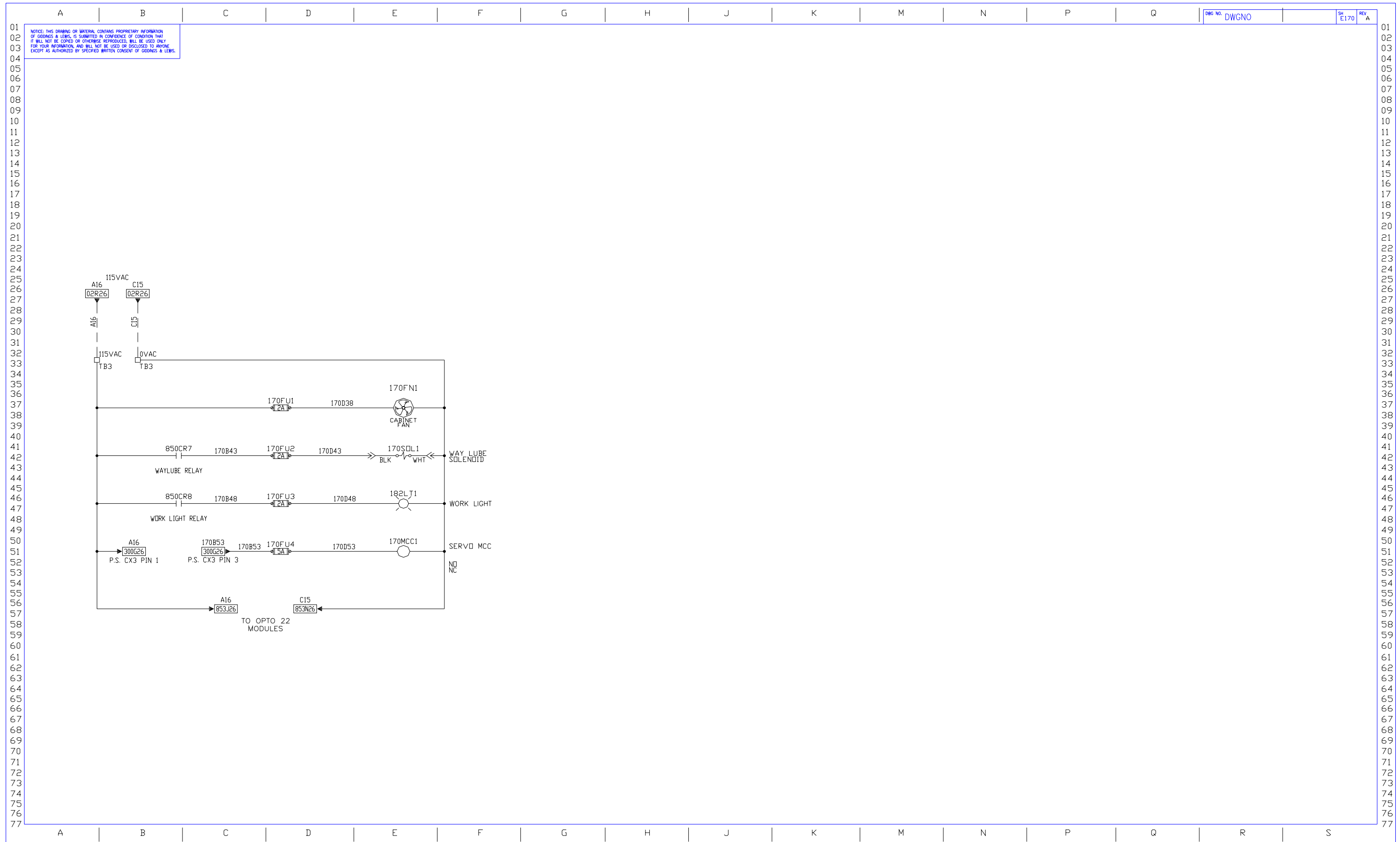

5.6 E171_115VAC POWER DISTRIBUTION_SHT2

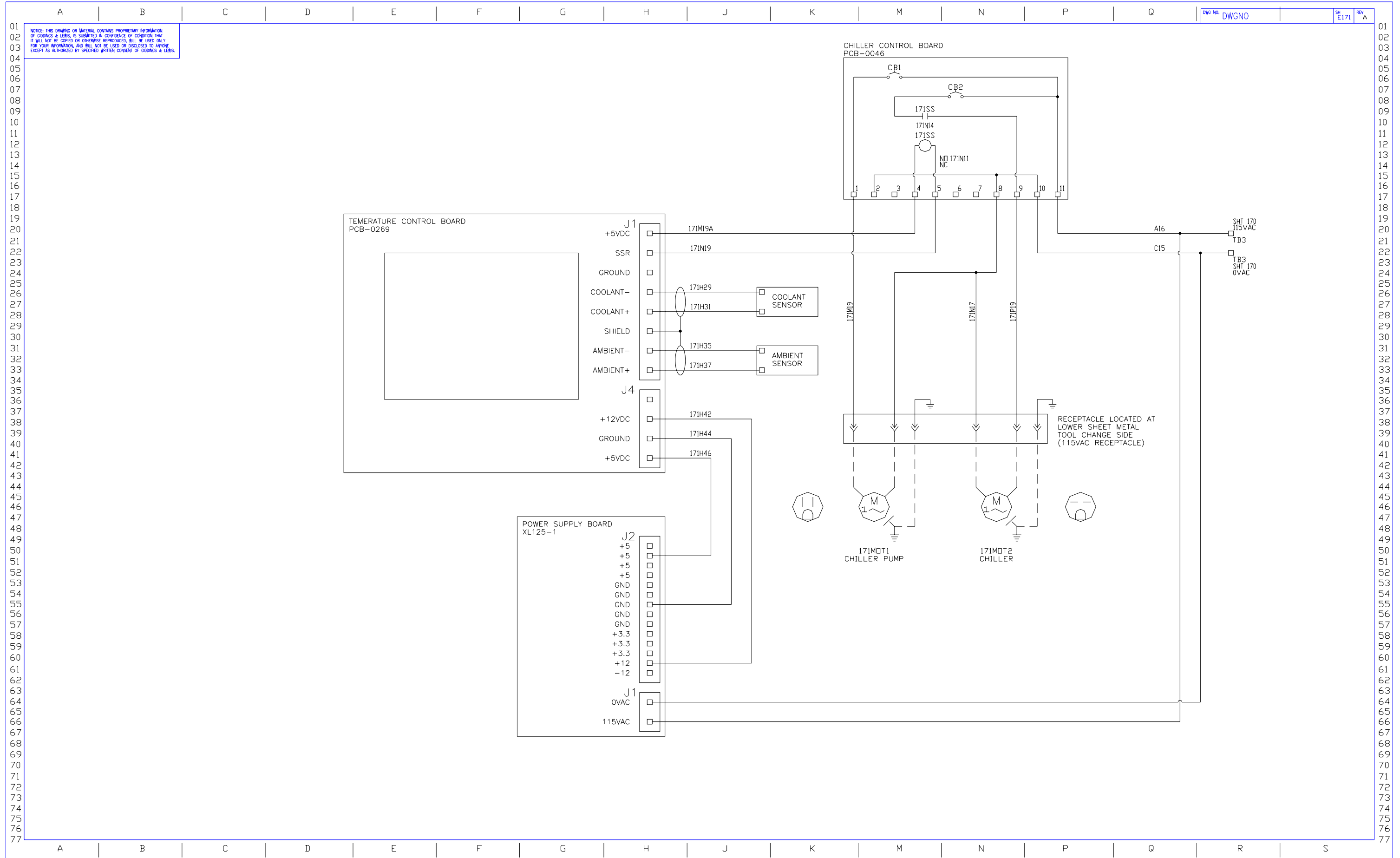

5.7 E172_115VAC POWER DISTRIBUTION_SHT3

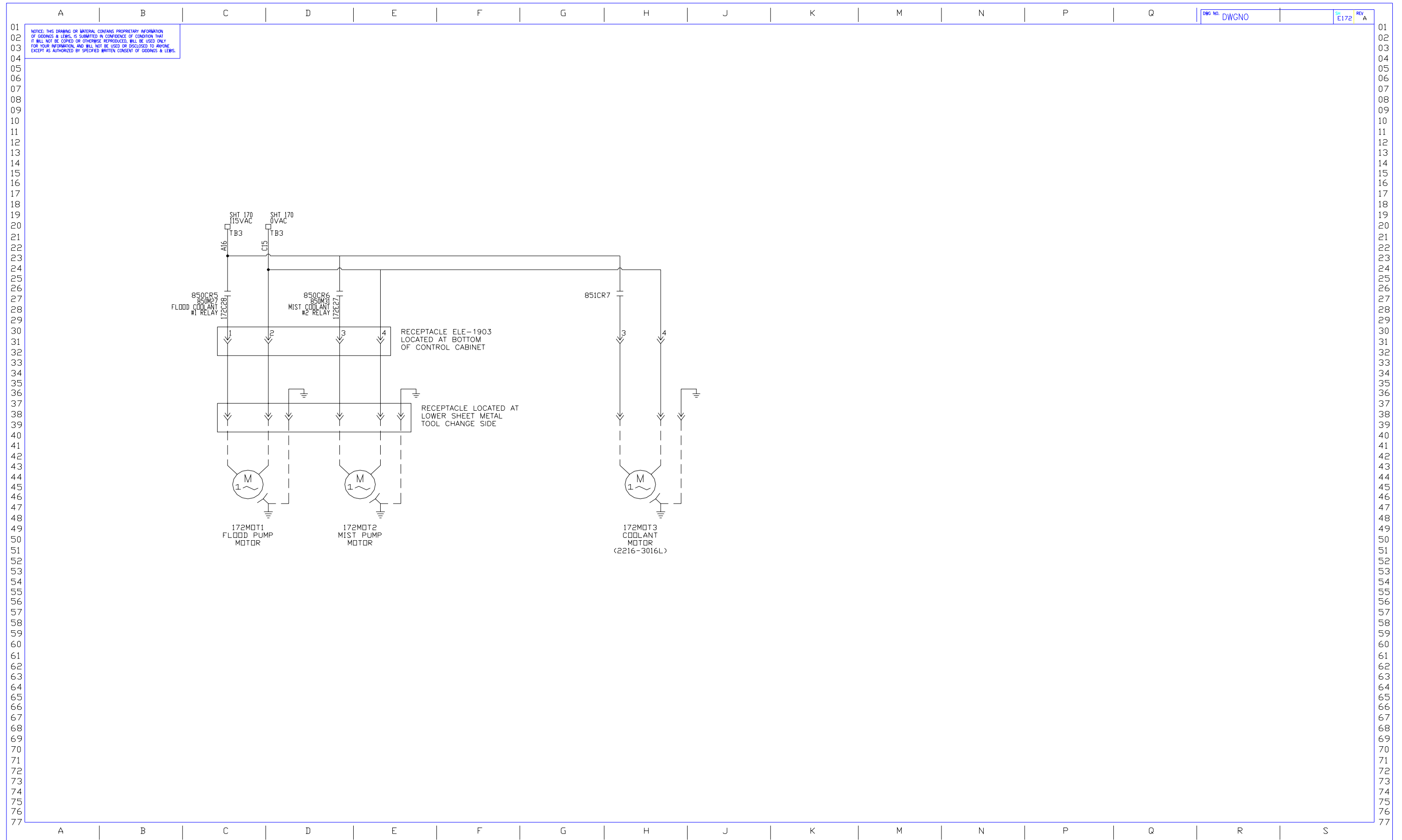

5.8 E173_115VAC POWER DISTRIBUTION_SHT4

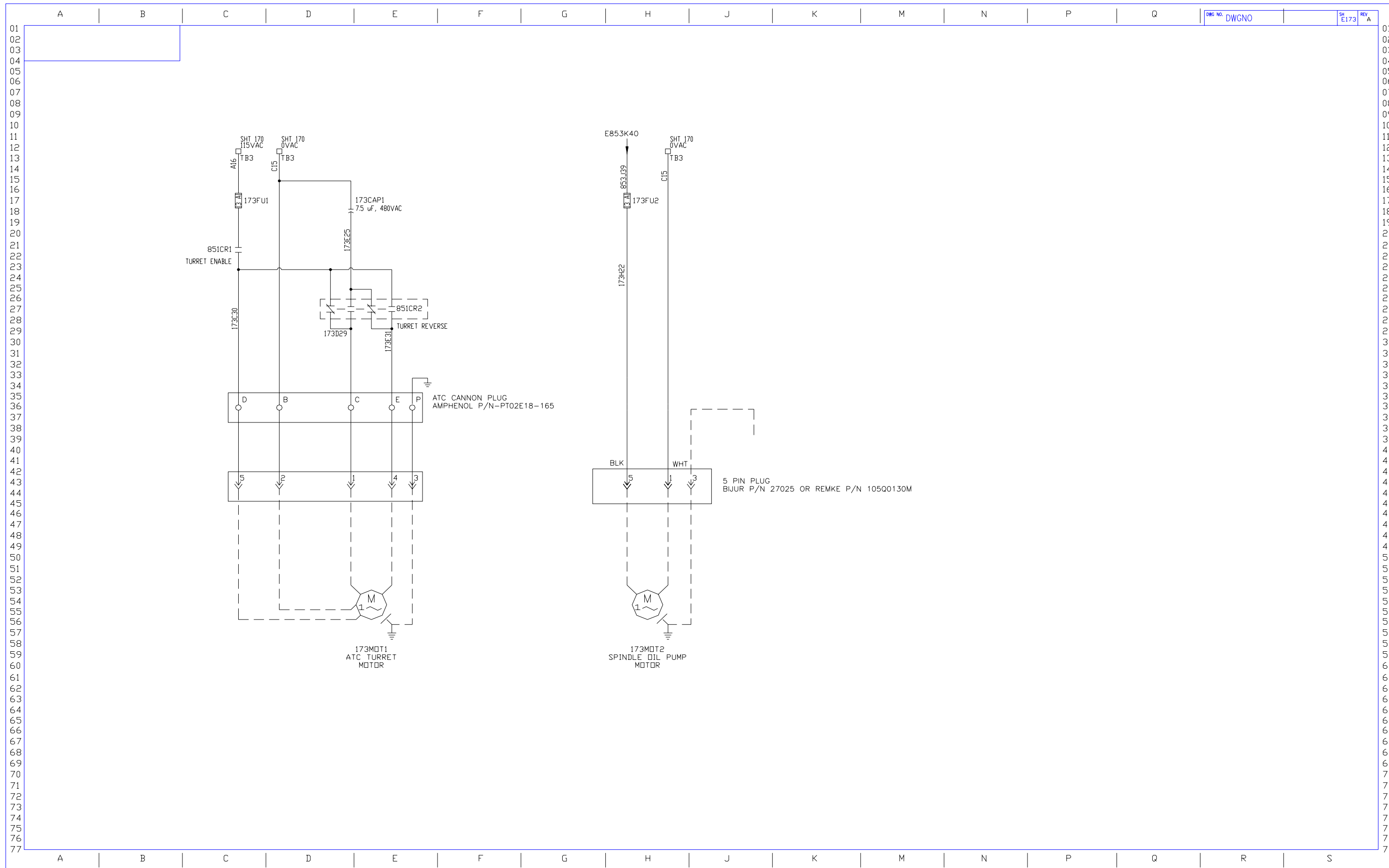

5.9 E180_24VDC POWER DISTRIBUTION

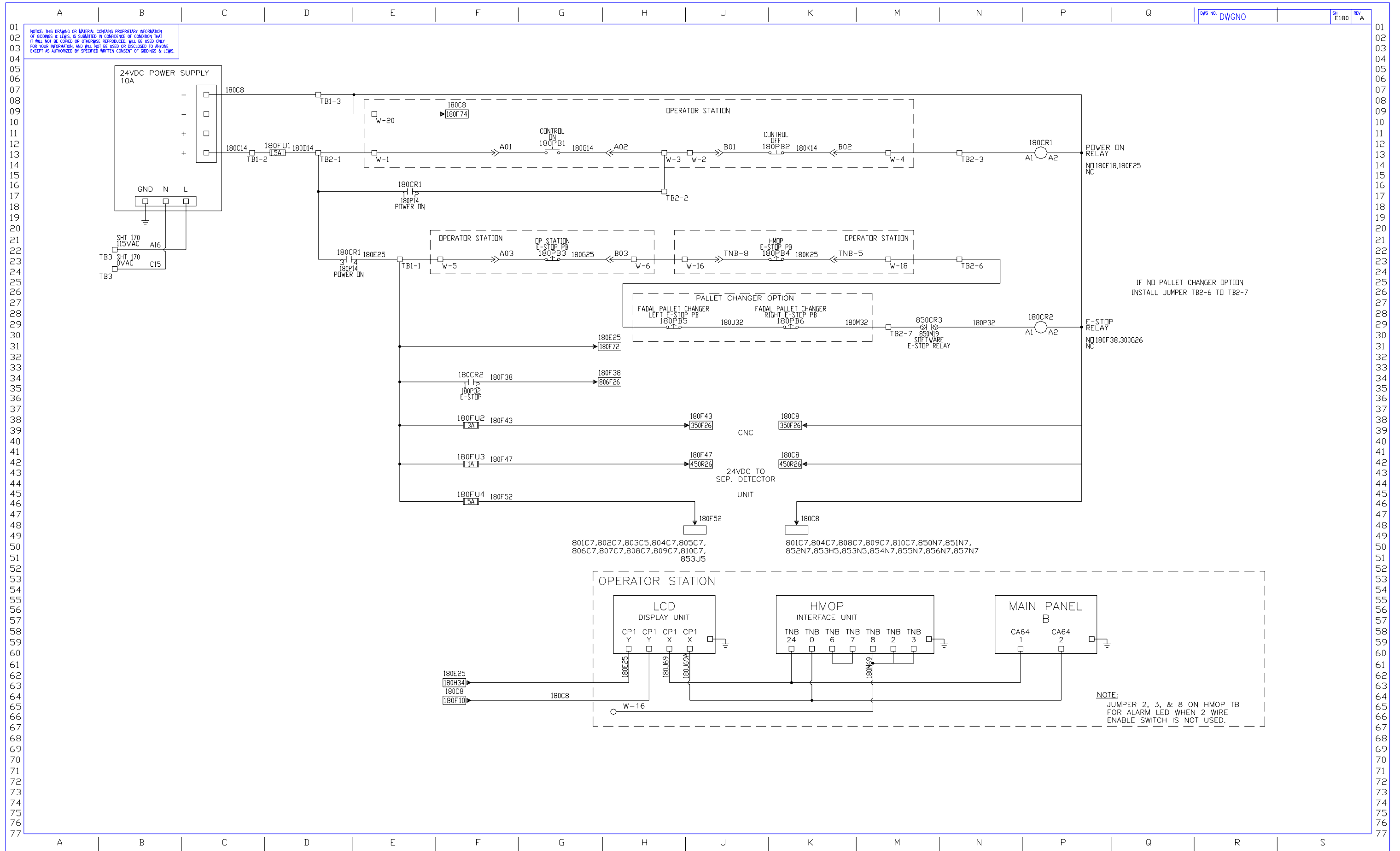

5.10 E300_DRIVES POWER SUPPLY WIRING DETAIL

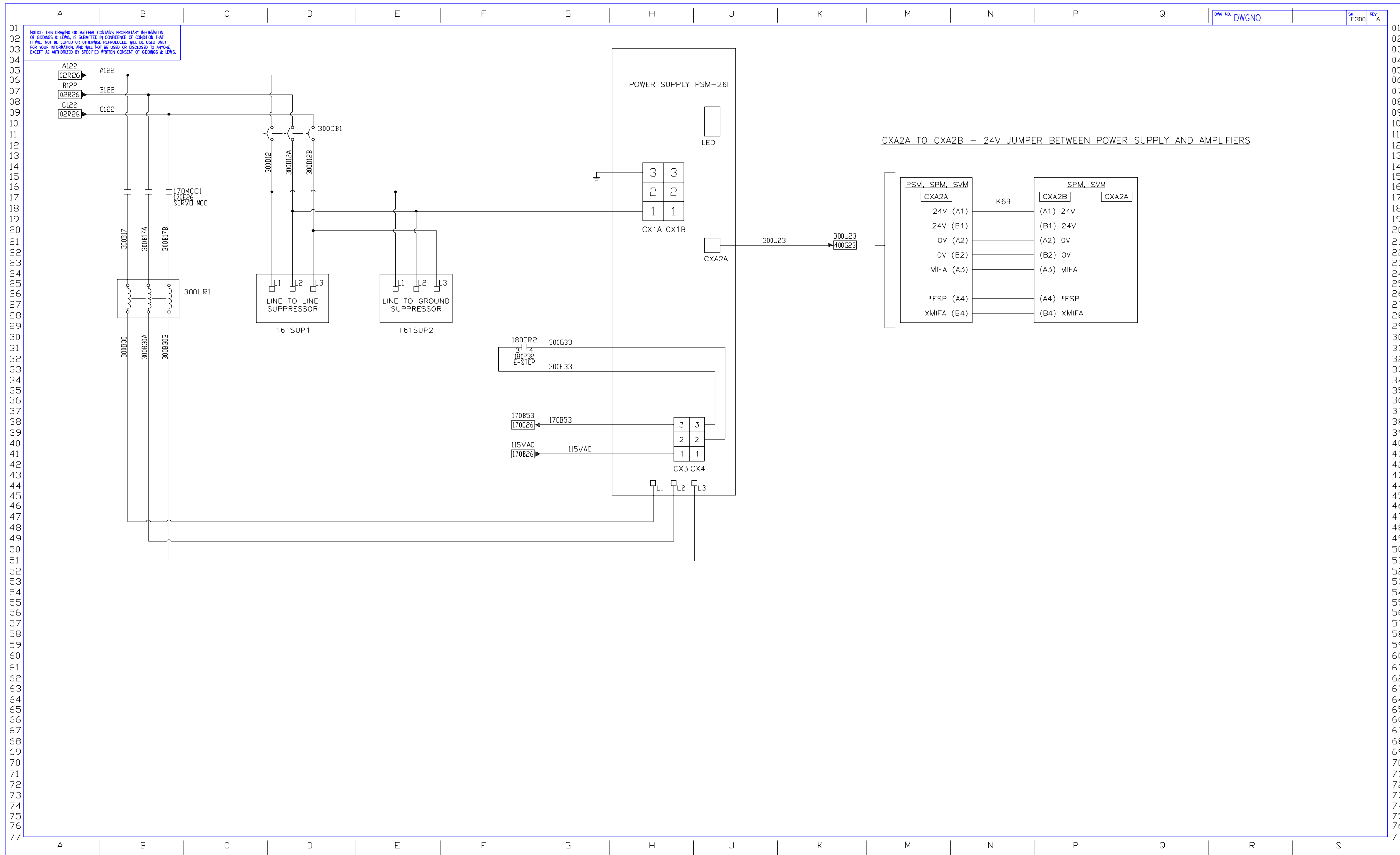

5.11 E350_DRIVES CNC CONTROL WIRING DETAIL

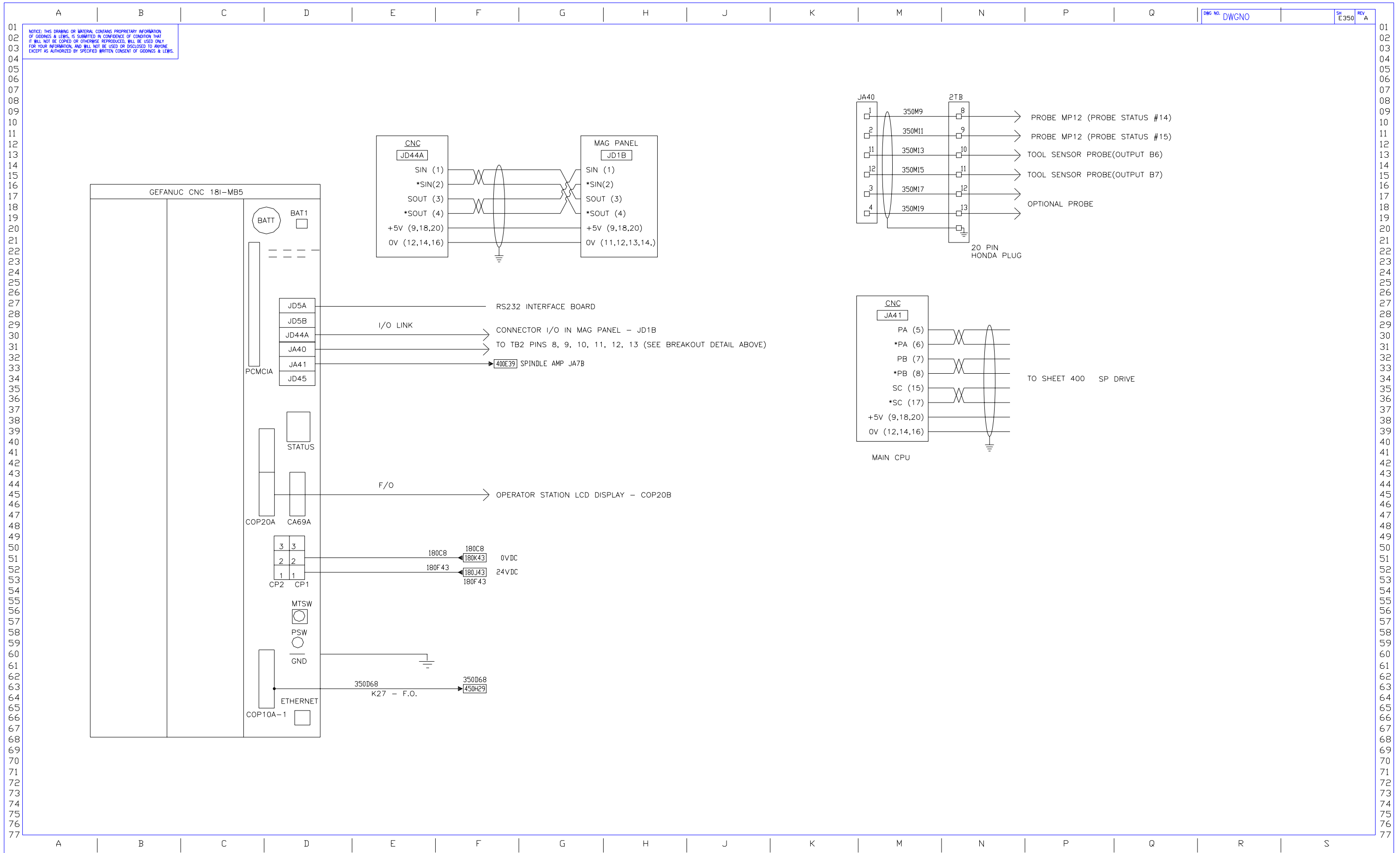

5.12 E400_SPINDLE AMP DRIVE WIRING DETAIL

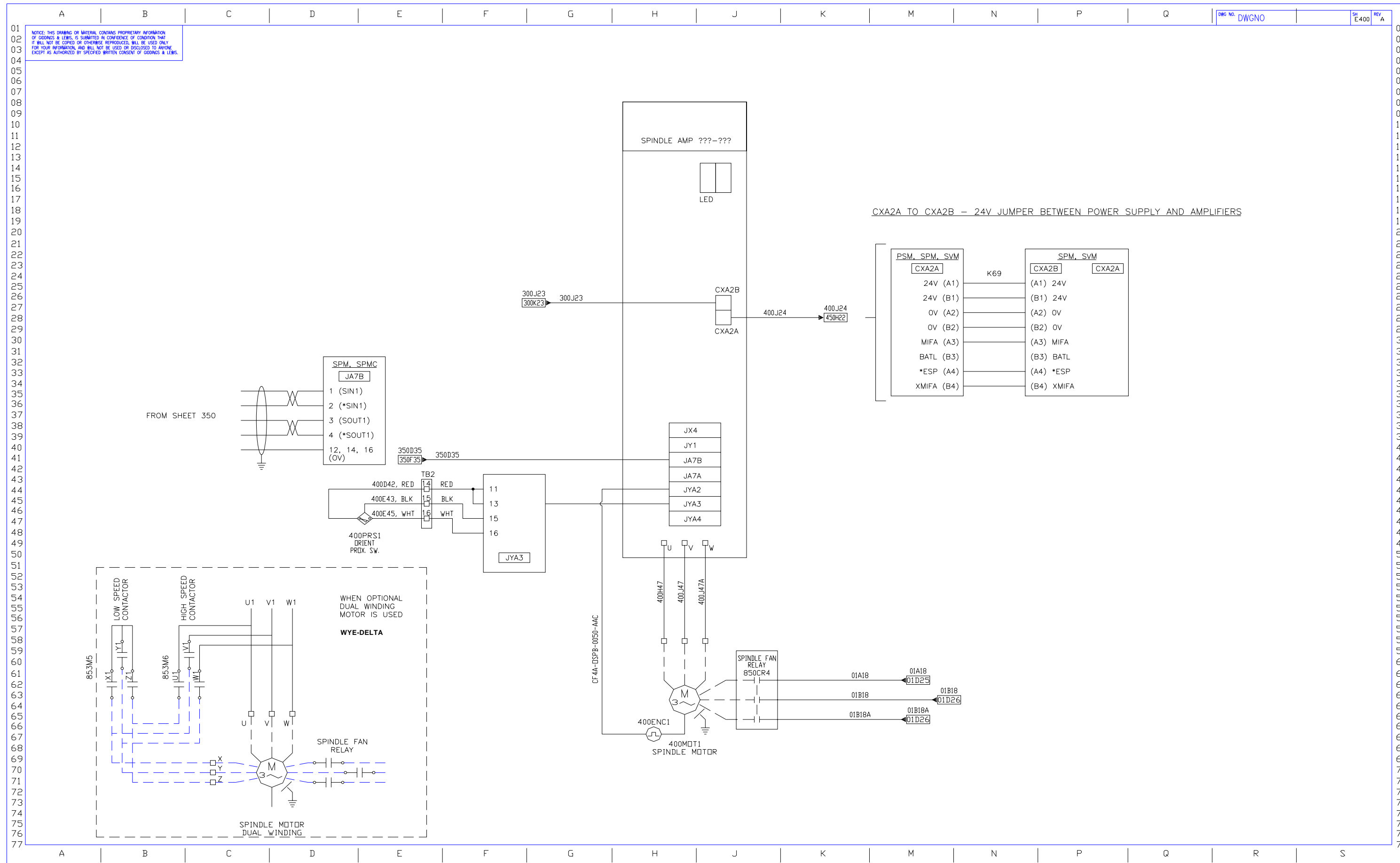

5.13 E450_SERVO AMP DRIVE WIRING DETAIL FOR X, Y, Z AXIS

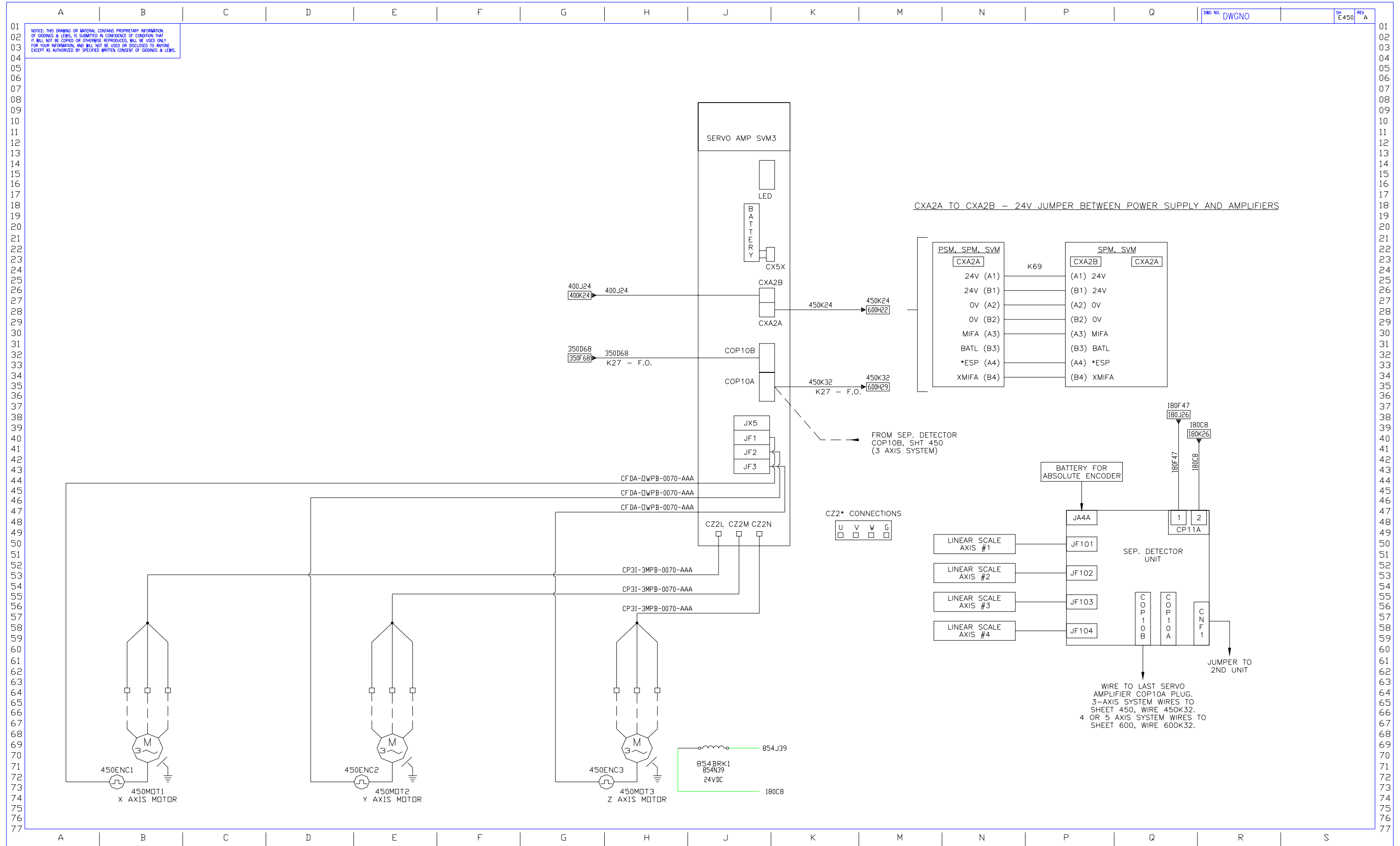

5.14 E600_OPTIONAL SERVO AMP DRIVE WIRING DETAIL FOR A & B AXIS MOTORS

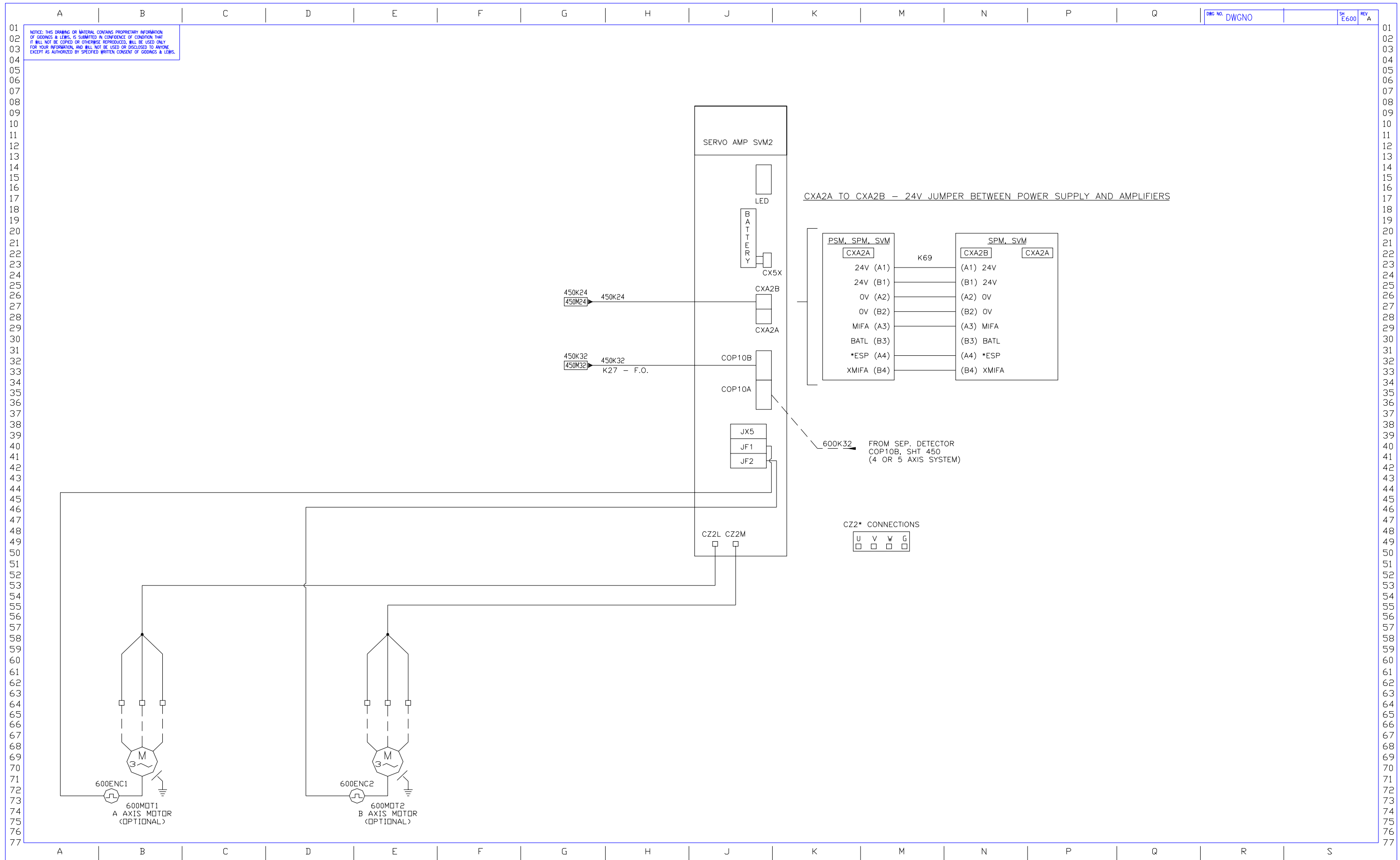

5.15 E801_INPUT CARD FOR C001 BOARD_SHT1

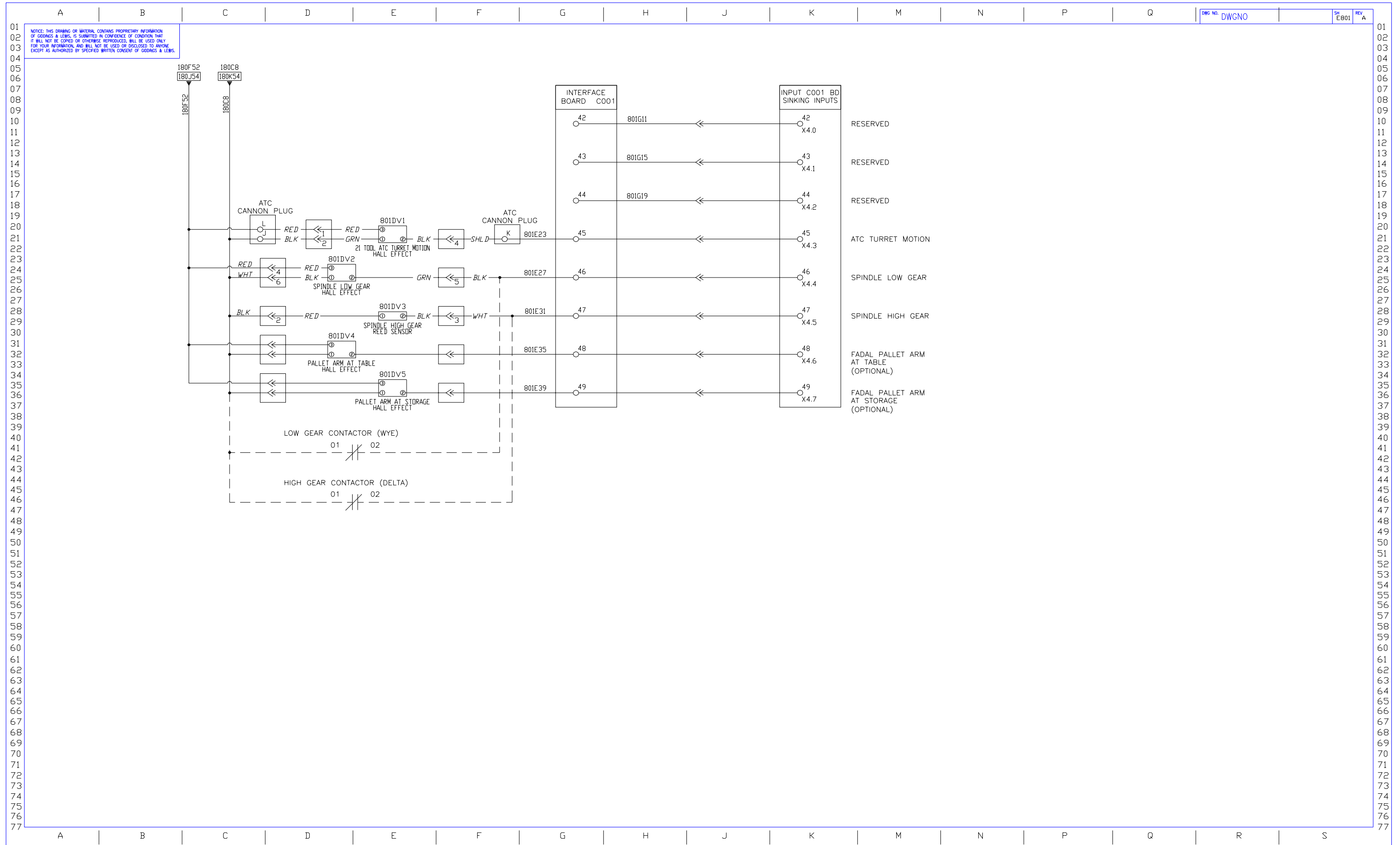

5.16 E802_INPUT CARD FOR C001 BOARD_SHT2

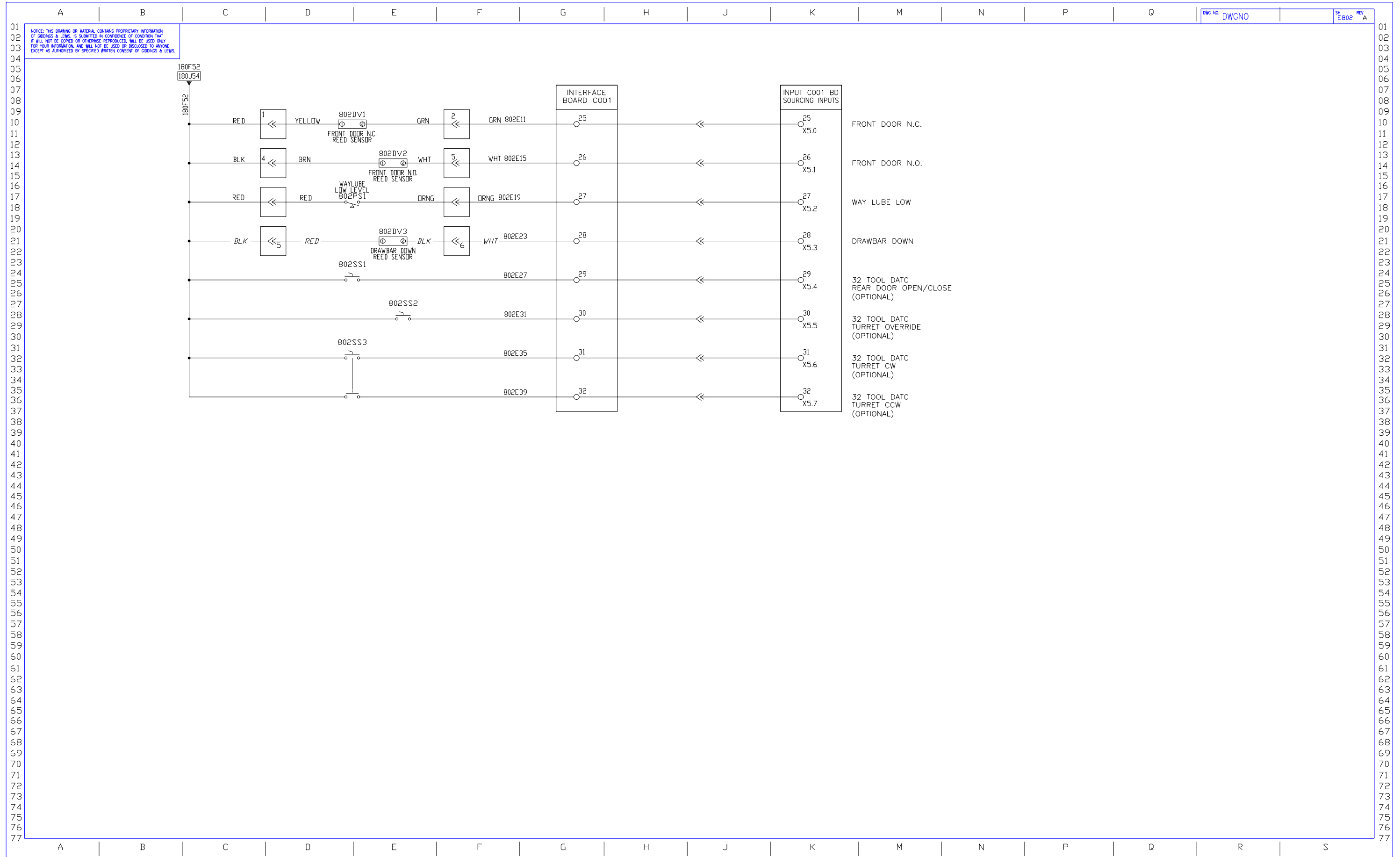

5.17 E803_INPUT CARD FOR C001 BOARD_SHT3

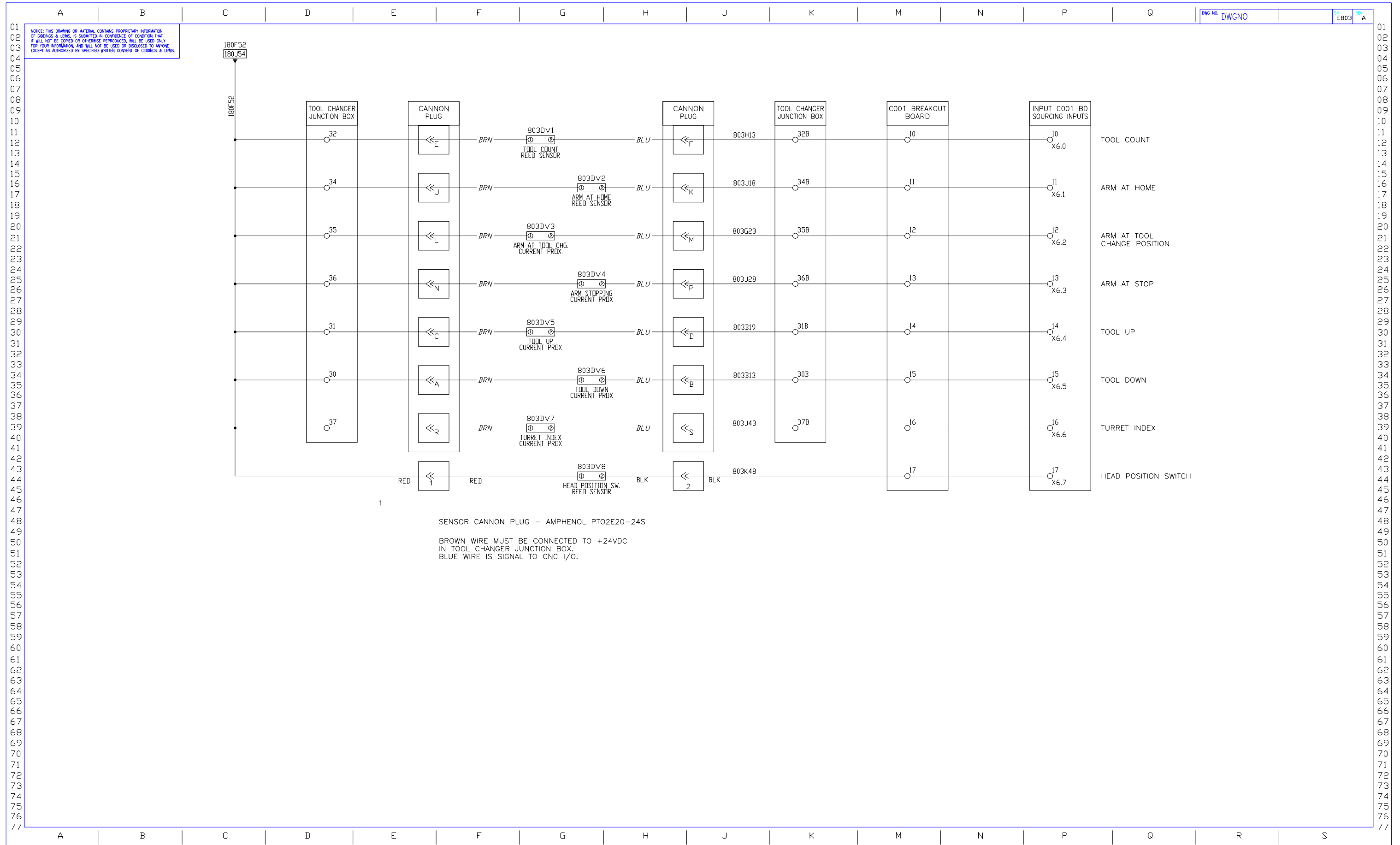

5.18 E804_C001 BOARD JUMPER SETUP DETAIL

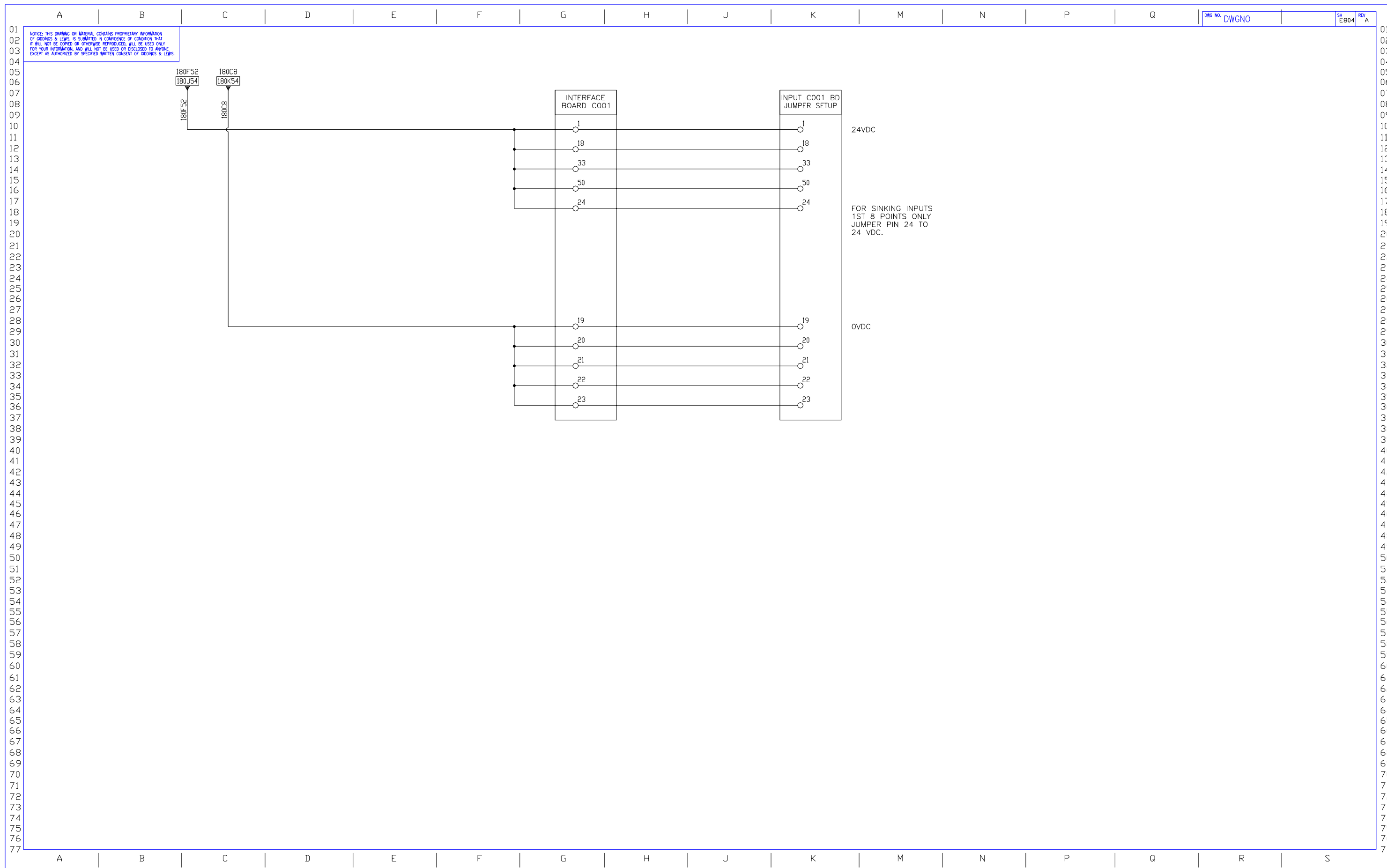

5.19 E805_INPUT CARD FOR C003 BOARD_SHT1

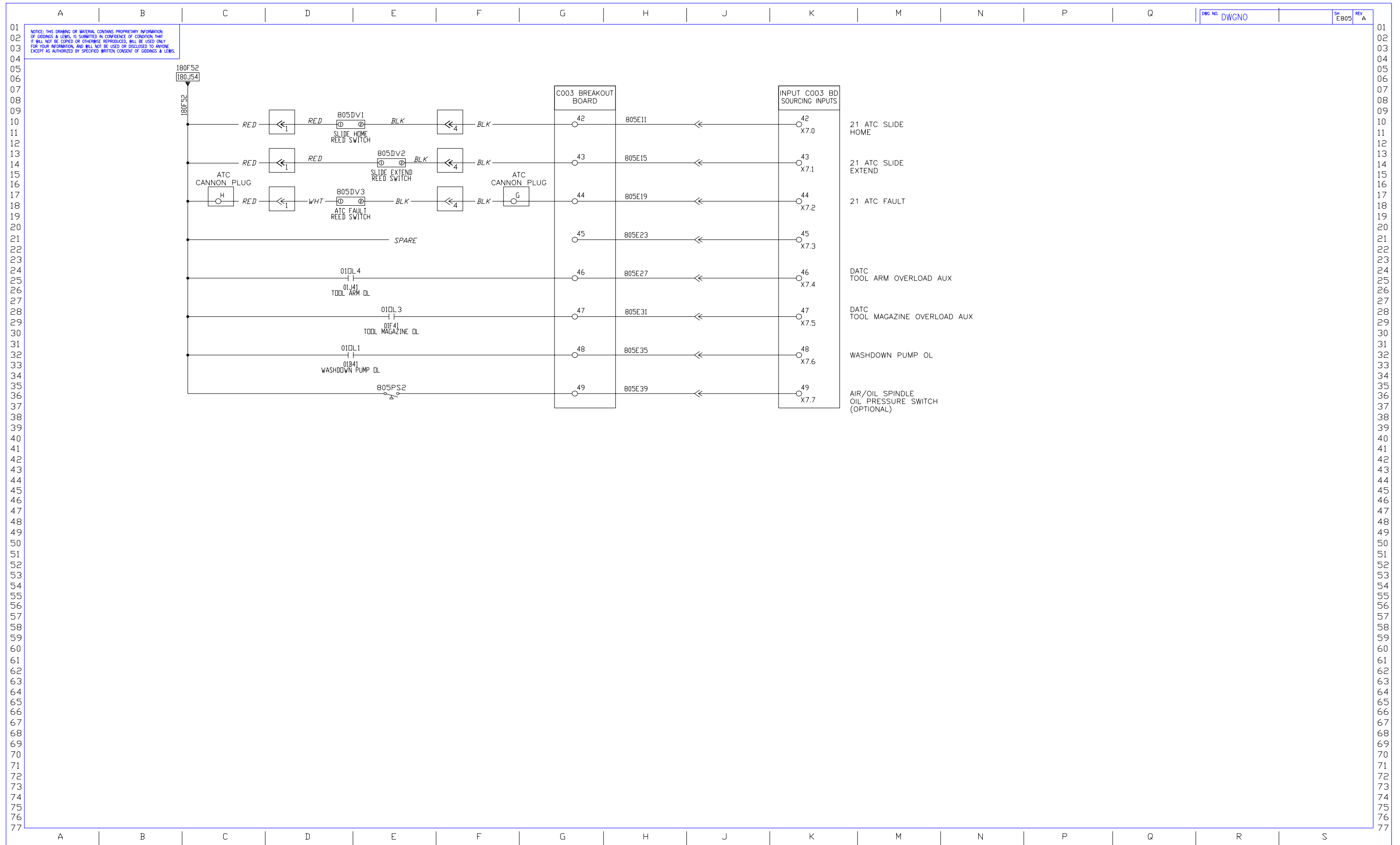

5.20 E806_INPUT CARD FOR C003 BOARD_SHT2

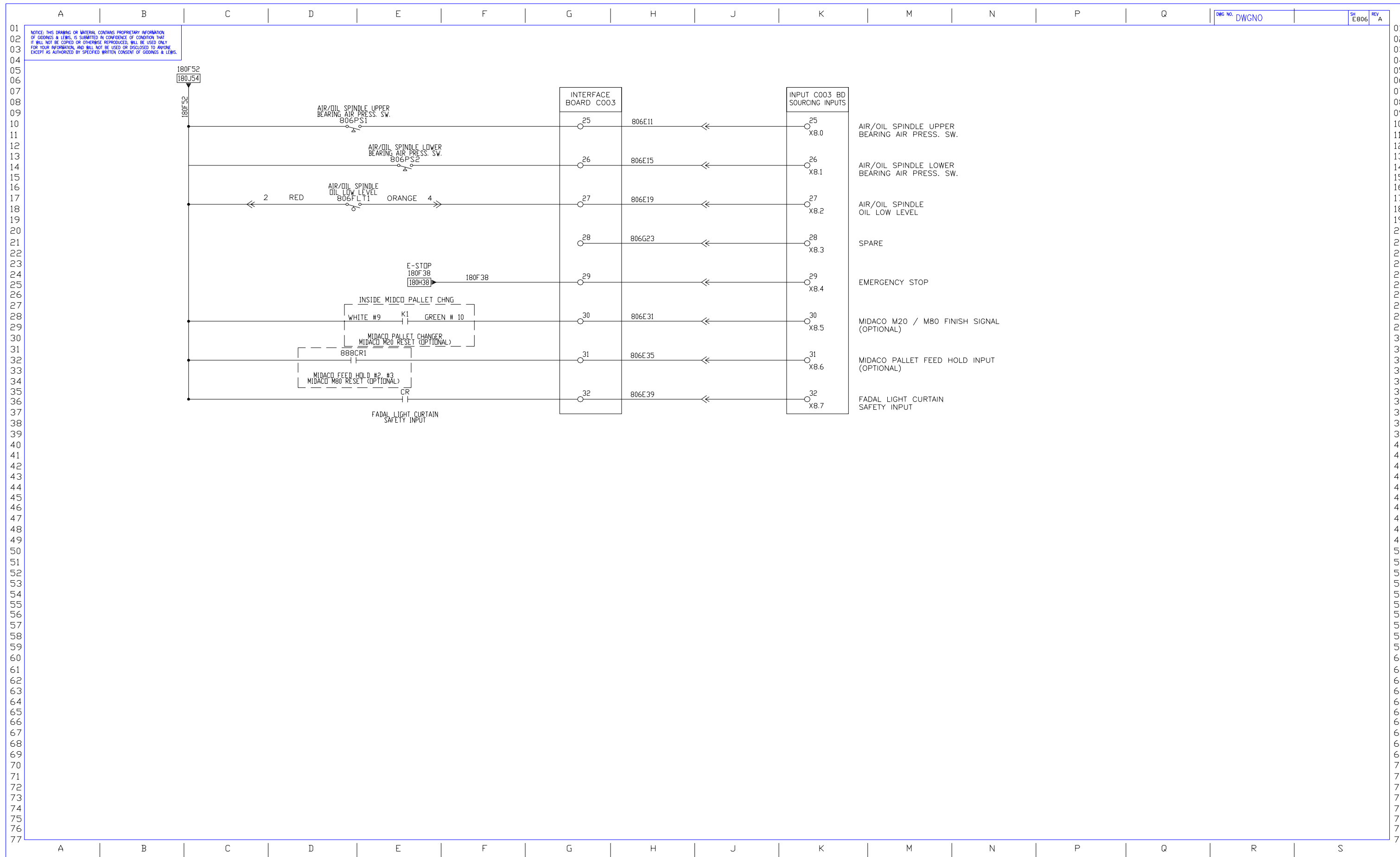

5.21 E807_INPUT CARD FOR C003 BOARD_SHT3

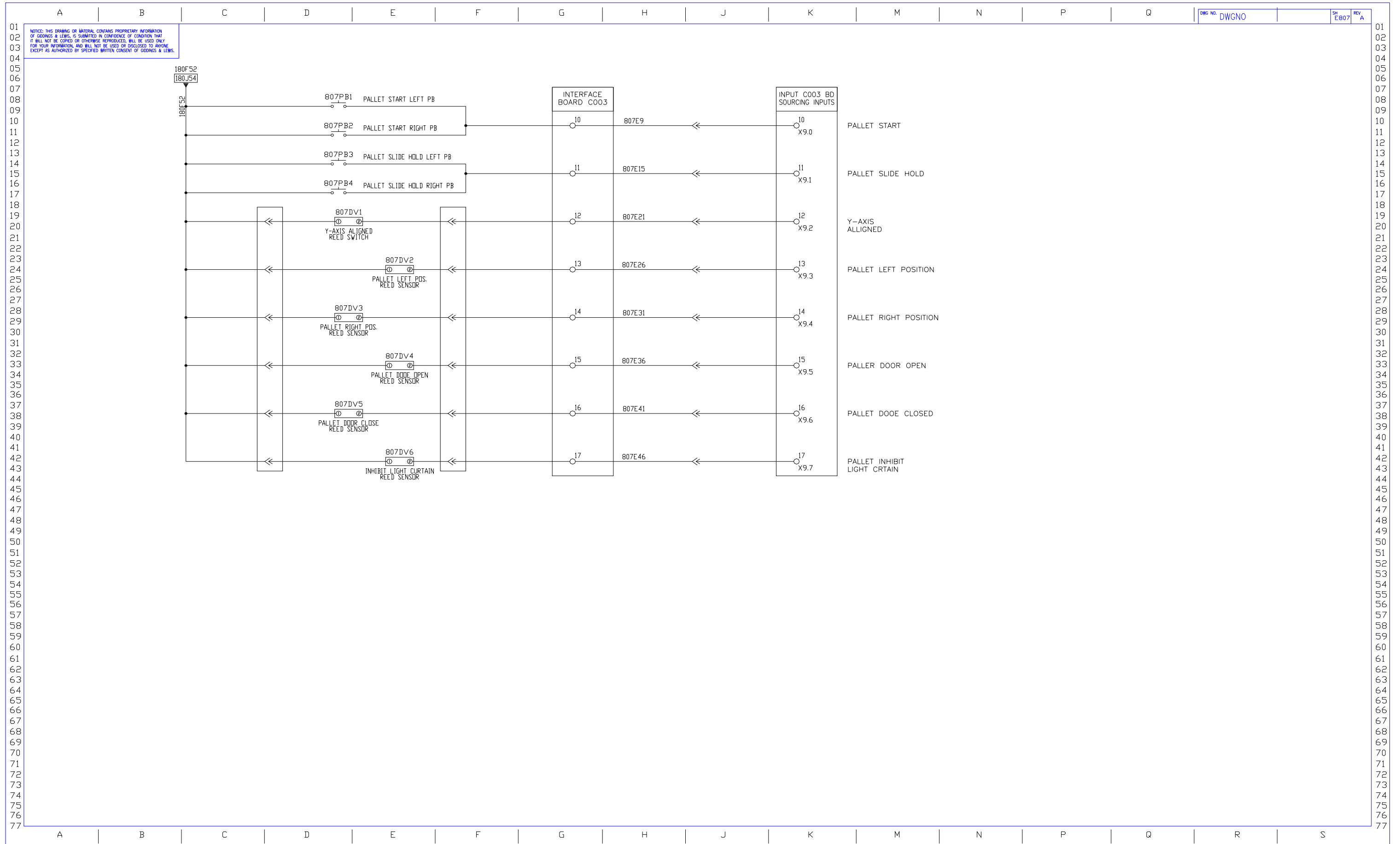

5.22 E808_C003 BOARD JUMPER SETUP DETAIL

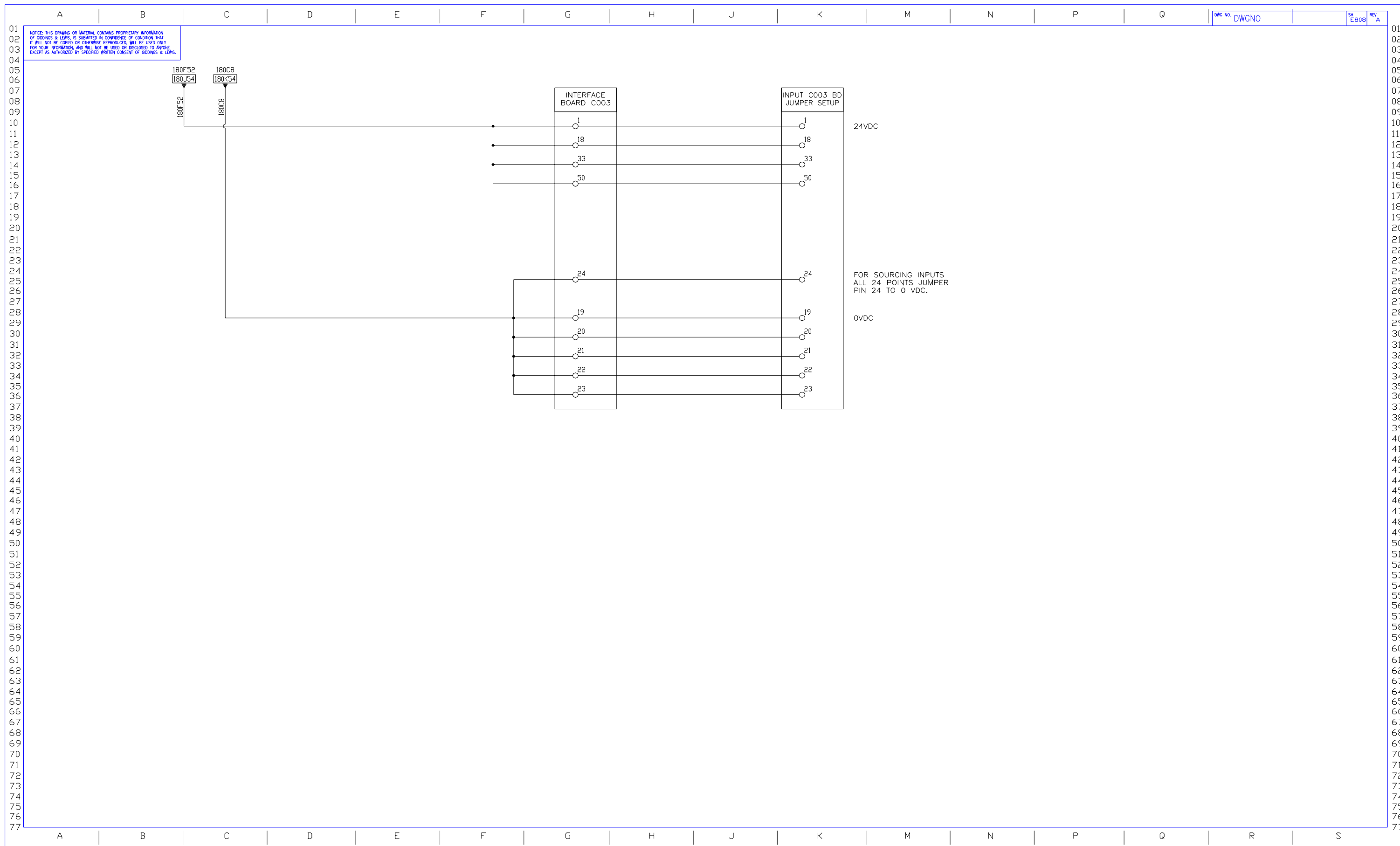

5.23 E809_C004 BOARD JUMPER SETUP DETAIL_SHT1

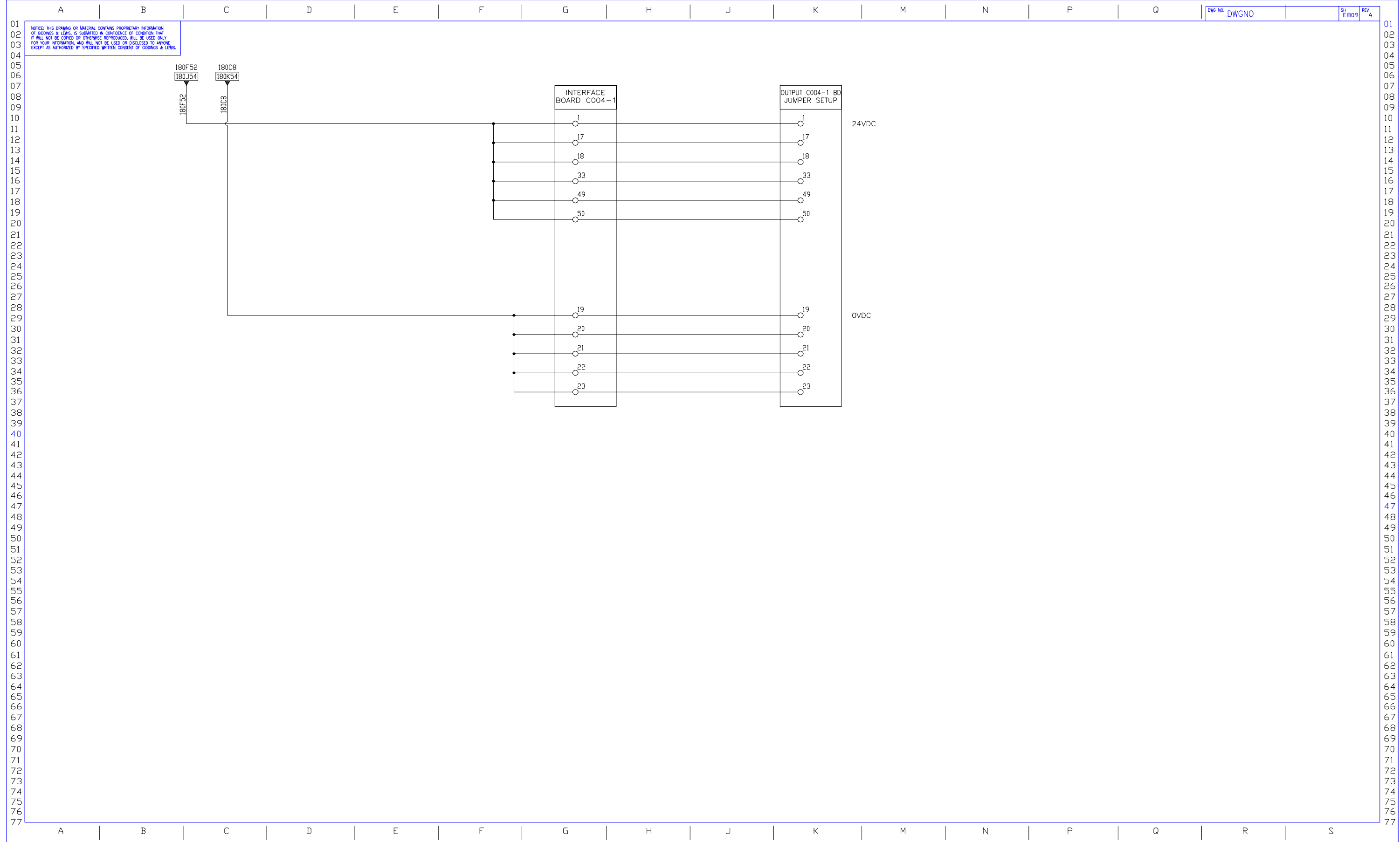

5.24 E810_C004 BOARD JUMPER SETUP DETAIL_SHT2

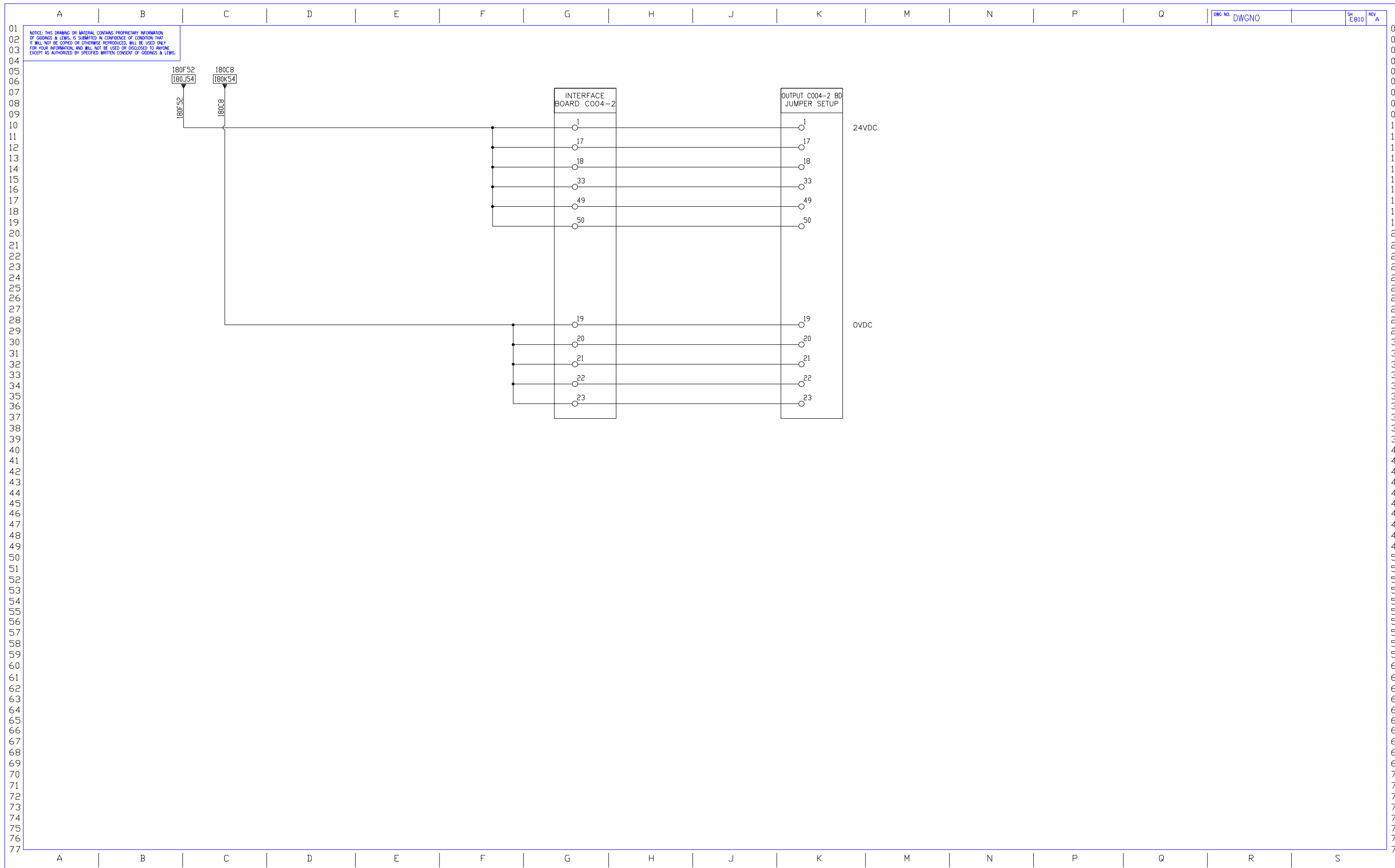

5.25 E850_OUTPUT CARD FOR C001 BOARD_SHT1

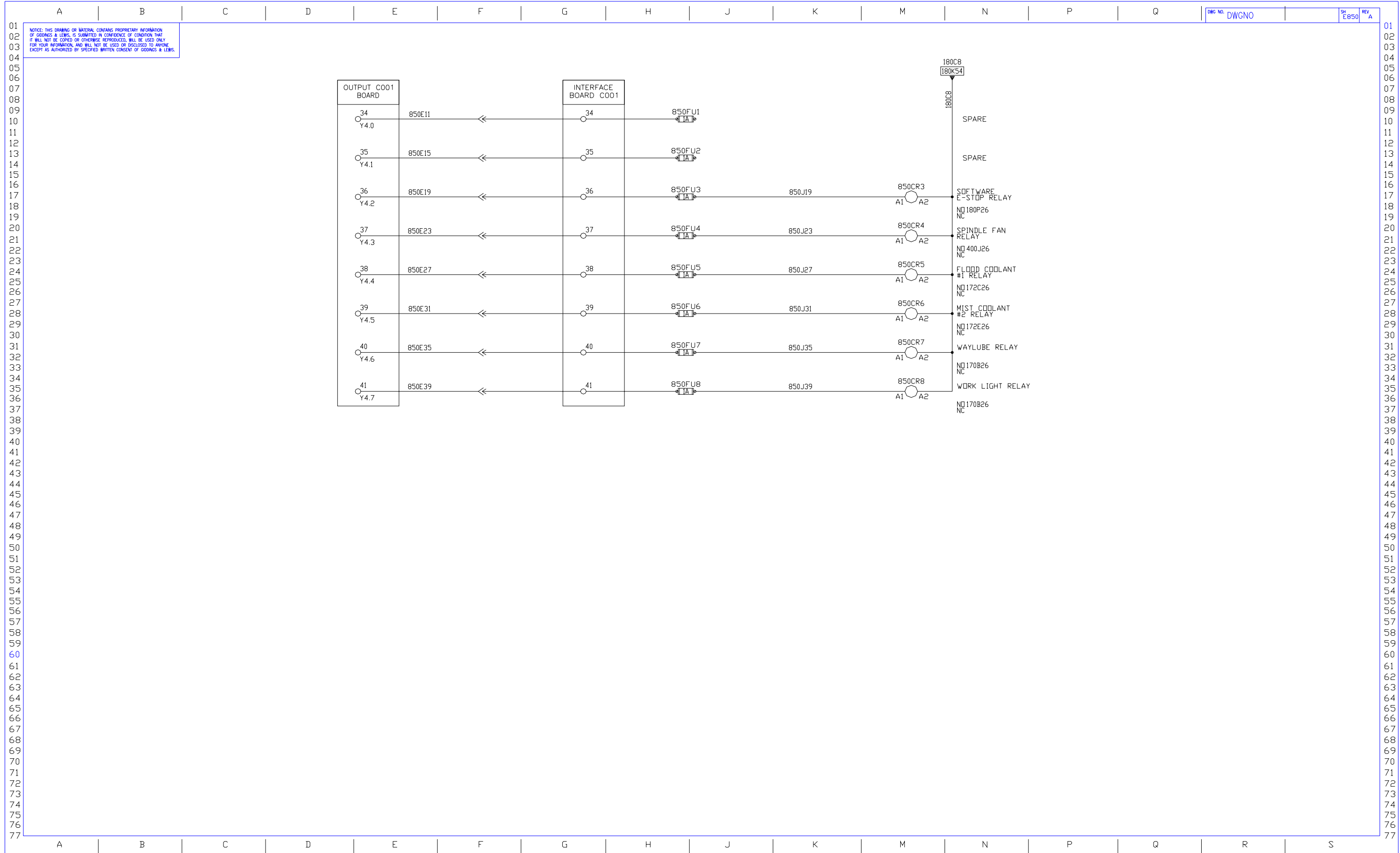

5.26 E851_OUTPUT CARD FOR C001 BOARD_SHT2

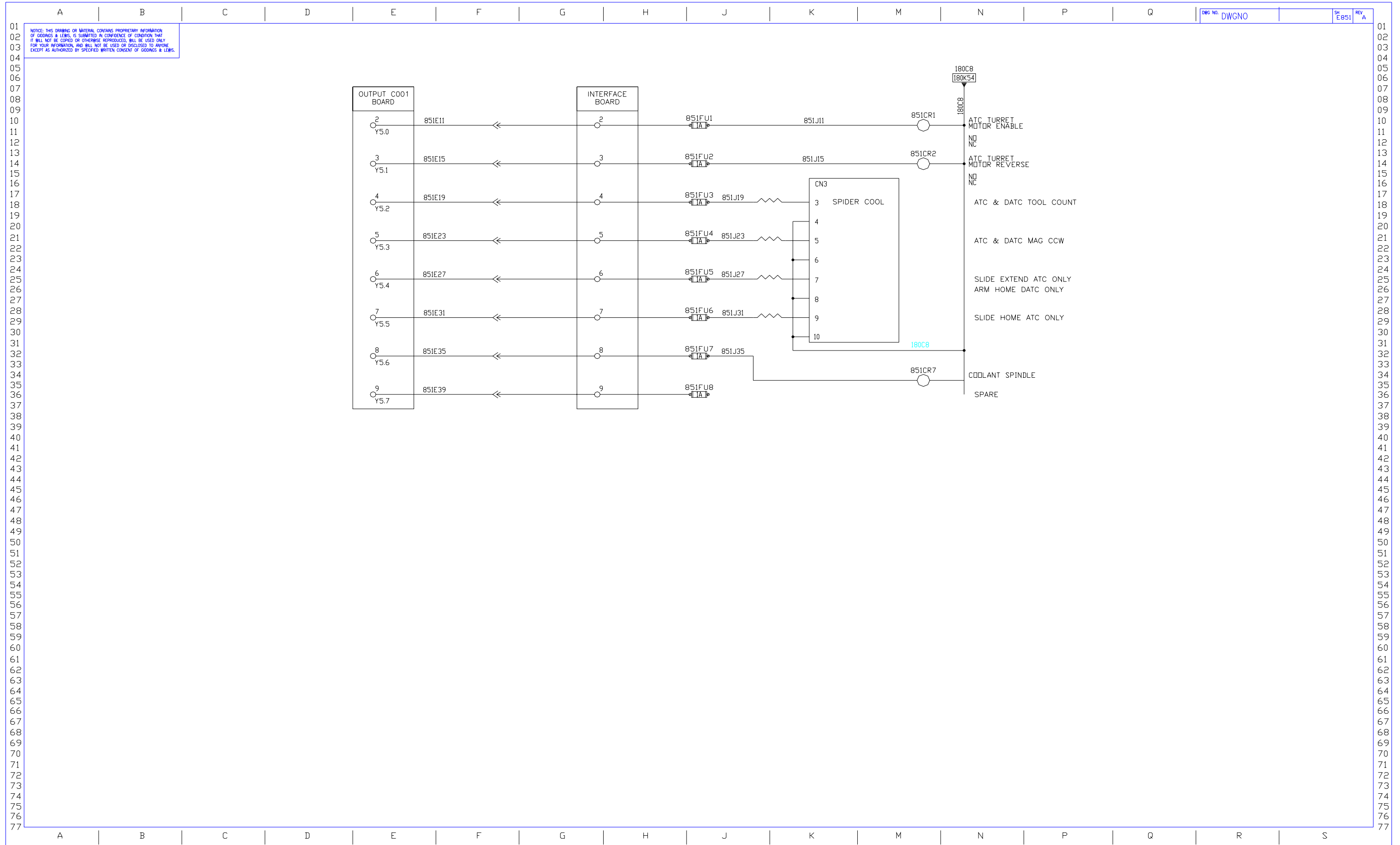

5.27 E852_OUTPUT CARD FOR C003 BOARD_SHT1

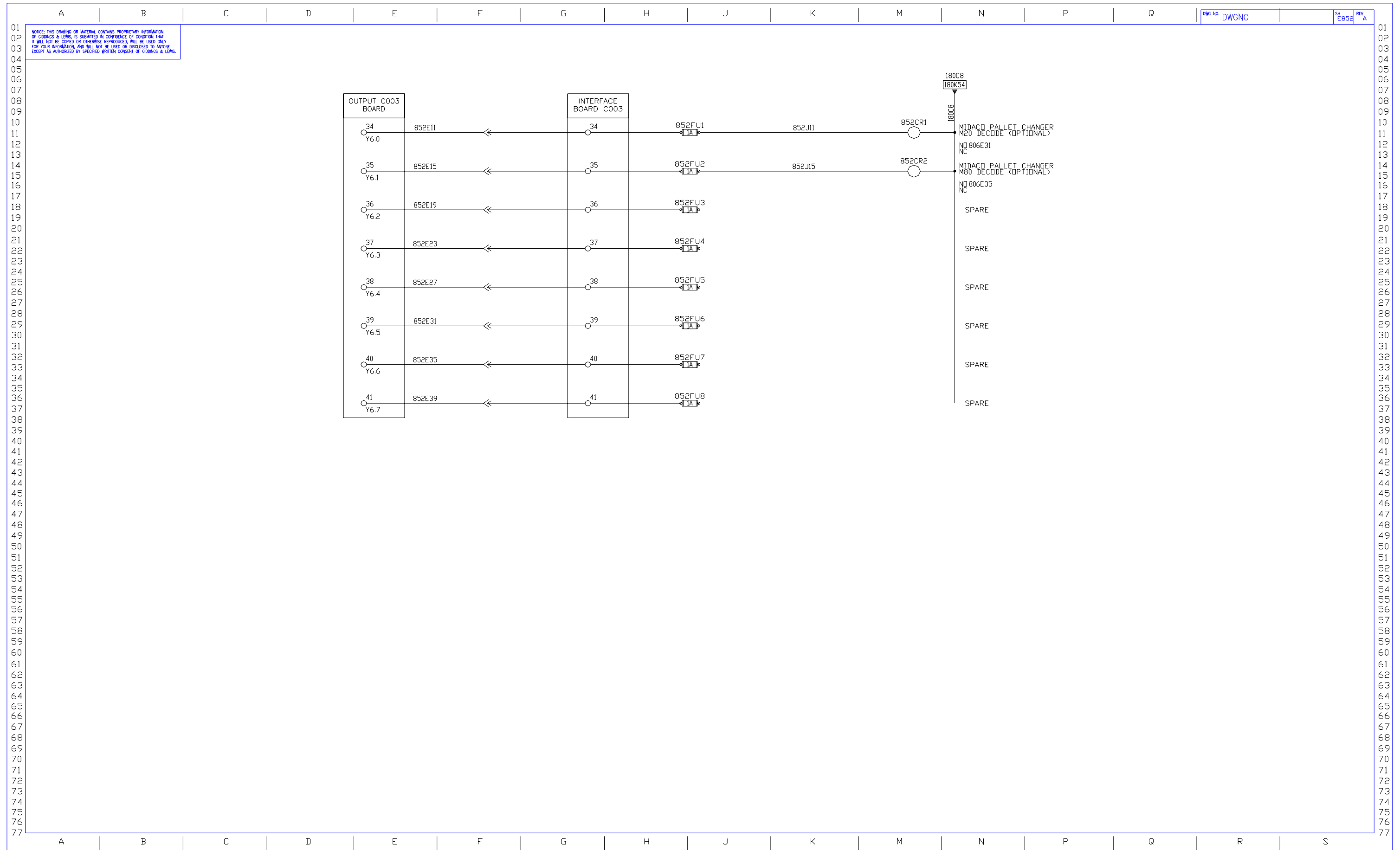

5.28 E853_OUTPUT CARD FOR C003 BOARD_SHT2

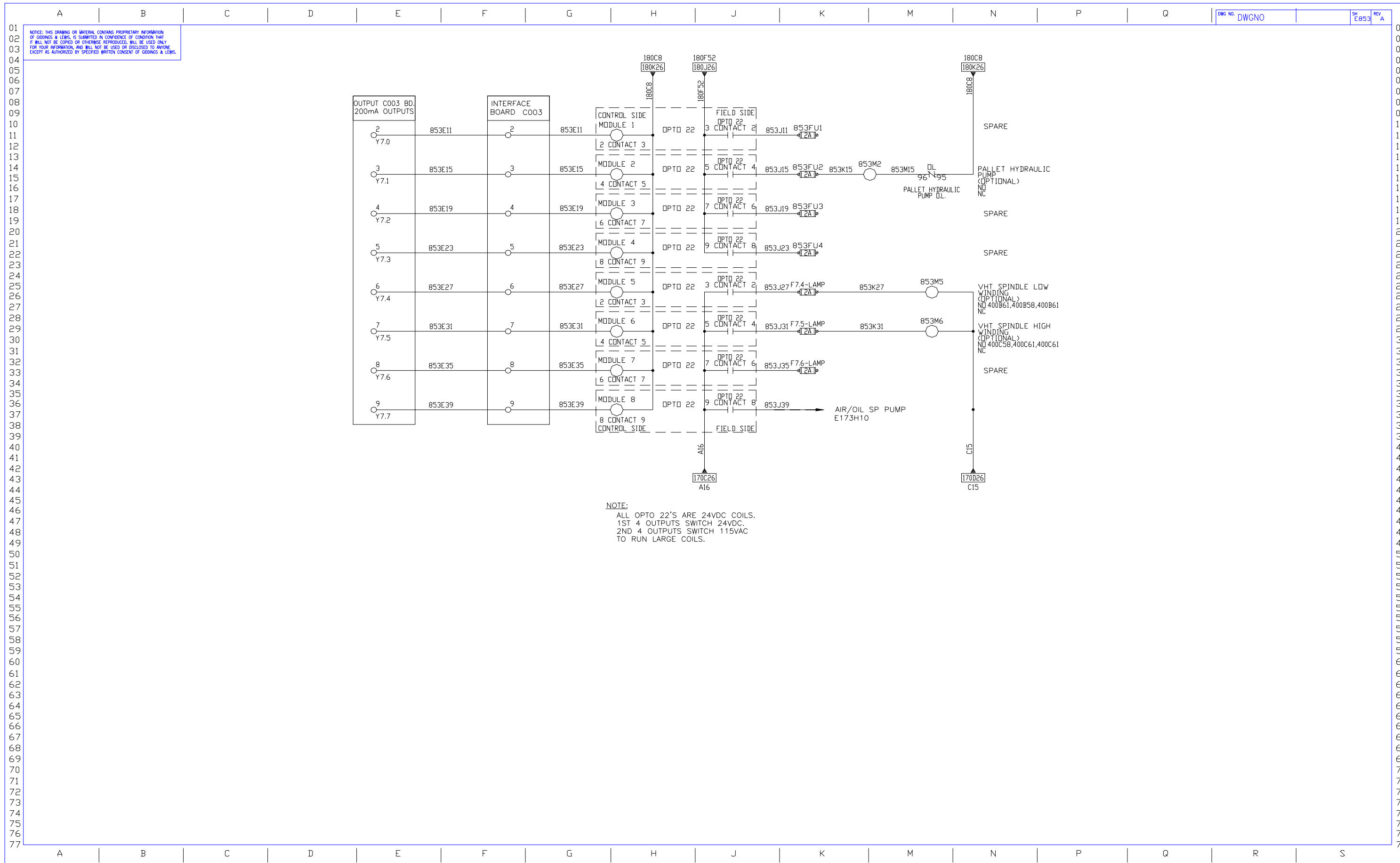

5.29 E854_OUTPUT CARD FOR C004-1 BOARD_SHT1

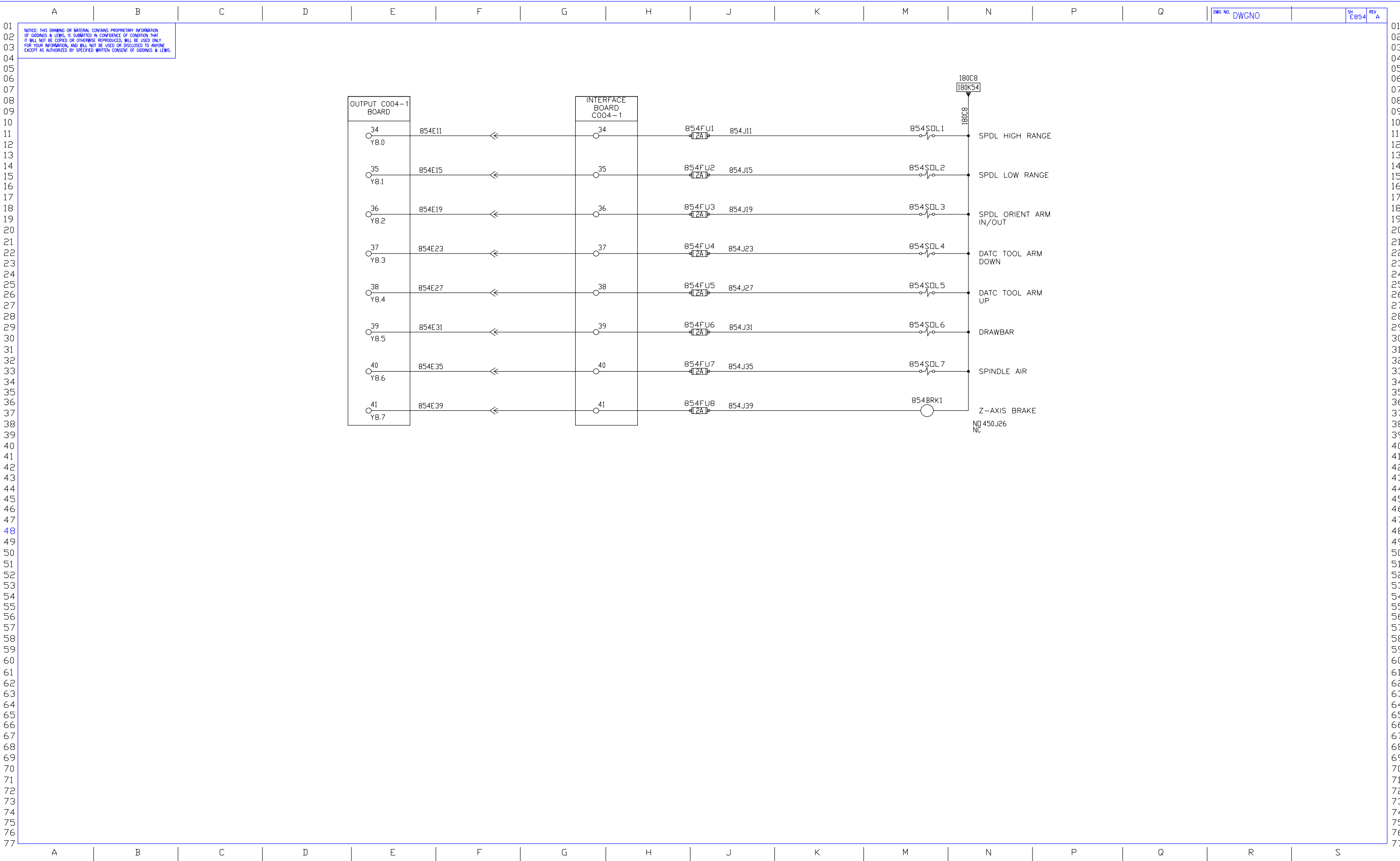

5.30 E855_OUTPUT CARD FOR C004-1 BOARD

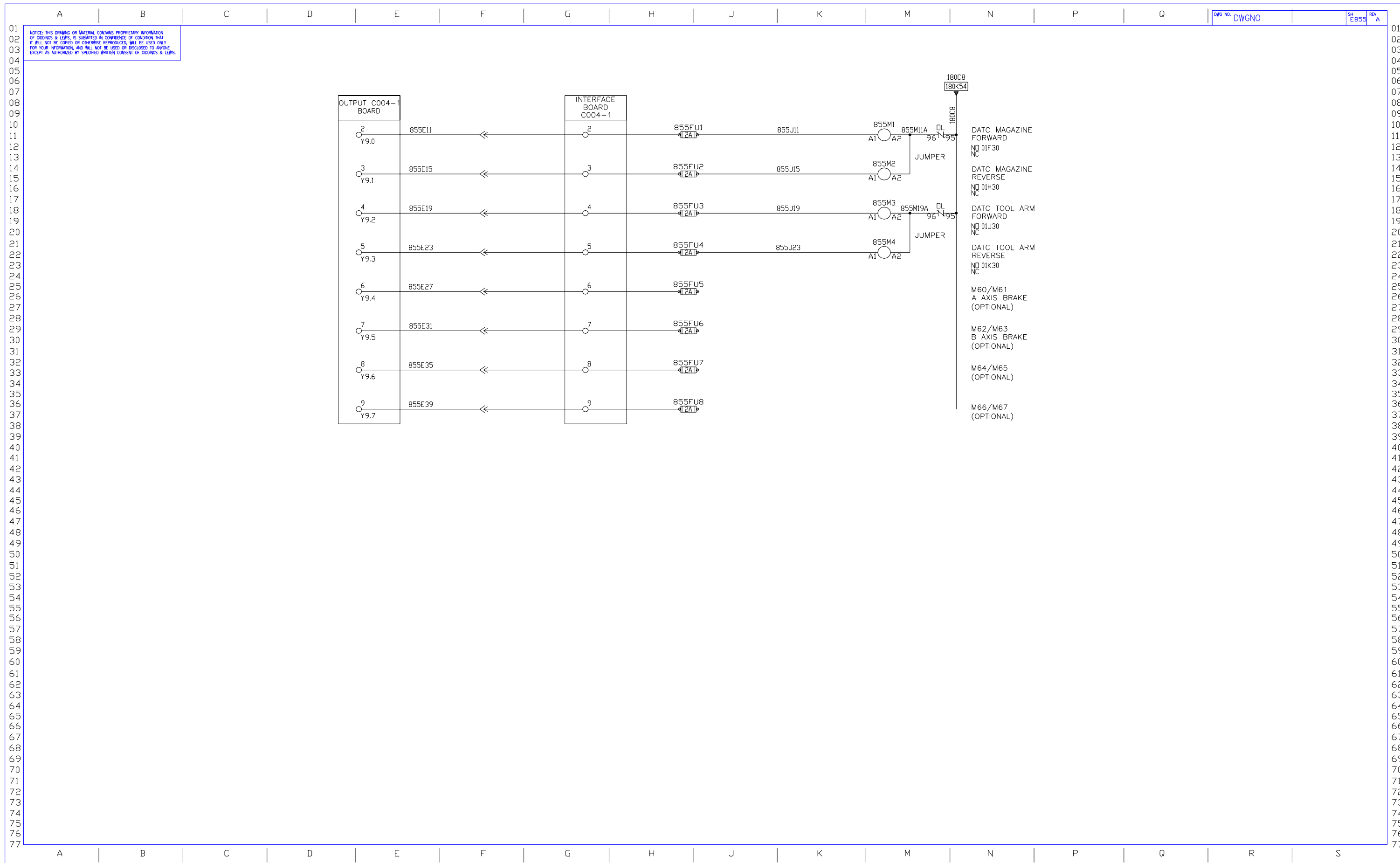

5.31 E856_OUTPUT CARD FOR C004-2 BOARD_SHT1

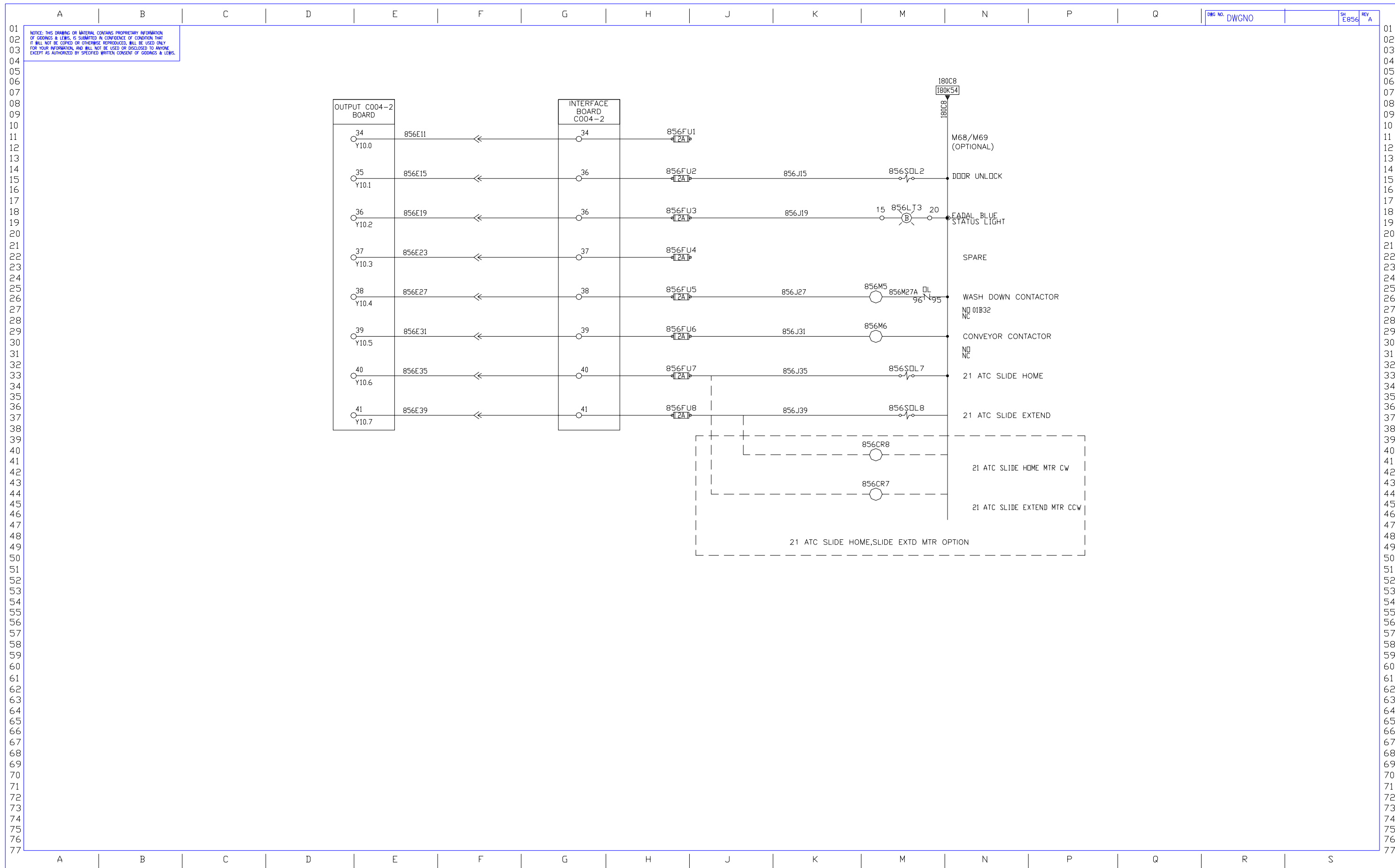

5.32 E857_OUTPUT CARD FOR C004-2 BOARD_SHT2

